

6.1: Swing Doors & Accessories	2
6.2: "New Cell" Swing Doors & Accessories	5
6.3: Gaskets & Frames	6
6.4: Swing Door Locks & Accessories	9
6.5: Swing Door Hinges	17
6.6: Swing Door Hinge Butts & Hinge Pins	22
6.7: Swing Door Holdbacks & Accessories	25
6.8: Door Seals & Locks	27
6.9: Todco Roll-Up Doors, Door Panels, & Accessories	34
6.10: Whiting Roll-up Doors, Door Panels & Accessories	48

6.1 Swing Doors & Accessories

6.1.1: PLYMETAL SWING DOORS

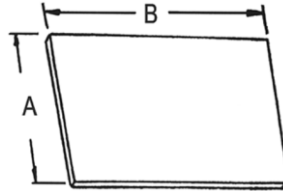

Part Number	Thickness	A	B	Outside Finish	Inside Finish
DOR2-1	1/2"	48-1/2"	120"	.015" White aluminum	.015" Mill finish aluminum
DOR2-2	1/2"	49"	110"	.020" Stainless steel	.015" Mill finish aluminum
DOR3-2	3/4"	48"	120"	.020" Stainless steel	.015" Mill finish aluminum
DOR3-3	3/4"	48-1/2"	120"	.015" Blue aluminum	24 Ga. galvanized
DOR3-10	3/4"	49"	110-1/2"	.015" White aluminum	.015" Mill finish aluminum
DOR3-11	3/4"	49"	110-1/2"	.015" Gray aluminum	.015" Mill finish aluminum
DOR3-12	3/4"	49"	110-1/2"	.015" Blue aluminum	.015" Mill finish aluminum
DOR3-13	3/4"	49"	120"	.015" White Aluminum	.015" Mill finish aluminum
DOR3-14	3/4"	49"	120"	.015" White aluminum	24 Ga. galvanized
DOR3-15	3/4"	49"	120"	.015" Mill finish aluminum	24 Ga. galvanized
DOR3-16	3/4"	49"	120"	.015" Metallic gray aluminum	.015" Mill finish aluminum
DOR3-17	3/4"	49"	144"	.015" White aluminum	.015" Mill finish aluminum
DOR3-31	3/4"	49"	110-1/5"	.015" White aluminum	24 Ga. galvanized
DOR4-1	1"	48"	108"	Quilted stainless steel	.015" Mill finish aluminum
DOR4-10*	1"	49"	110-1/2"	24 Ga. White galvanized	24 Ga. galvanized
DOR4-11	1"	49"	121"	.015" White aluminum	24 Ga. galvanized
DOR4-4	1"	48-1/2"	108"	.015" White aluminum	.015" Mill finish aluminum
DOR5-2*	1-1/4"	48-1/2"	108"	24 Ga. White galvanized	24 Ga. galvanized
DOR5-8*	1-1/4"	49"	110-1/2"	24 Ga. White galvanized	24 Ga. galvanized
DOR5-9*	1-1/4"	49"	110-1/2"	24 Ga. Gray galvanized	24 Ga. galvanized



*AAR spec'd doors

6.1.2: PLYMETAL & FOAM CORE SWING DOOR SEALS & RETAINERS







6.1.2.1: DUAL DUROMETER DOOR SEALS

Part Number	A	Door Thickness	Length	Type	Figure
DOR1-2	9/16"	1/2"	168"	Economy	
DOR1-4	13/16"	3/4"	168"	Economy	
DOR1-6	13/16"	3/4"	168"	Premium	
DOR1-6A	13/16"	3/4"	168"	Fleet Loc	
DOR1-7	13/16"	3/4"	168"	Standard	
DOR1-8	1-1/16"	1"	168"	Economy	
DOR1-9	1-1/16"	1"	168"	Standard	
DOR1-10	1-5/16"	1-1/4"	168"	Economy	
DOR1-11	1-5/16"	1-1/4"	168"	Standard	
DOR1-12	1-9/16"	1-1/2"	168"	Standard	



6.1.2.2: NEWCOURT 3/4" ALUMINUM RETAINERS

		
1. NEC6203-071 14'	1. NEC6342 14'	1. NEC6349 14'





6.1.2.3: NEWCOURT 3/4" DOOR SEAL

		
1. NEC6237-871 14'	1. NEC6292-871 14' 2. NEC6292-6492 With insert	1. NEC6340 A = 9/16" 2. NEC6346701 A = 11/16"
		
1. NEC6583771 14'	1. NEC6609771 14'	1. NEC6256-831 122"
Door Seal Only Picture Frame Door Seal 3/4" x 49" x 11-3/8" uses NEC6292-6492 door seal used with NEC6203-071 retainer		
1. NEC72403080 C/S Complete 2. NEC72403081 R/S Complete		

6.1.2.4: 3/4" DOOR SEAL & TRIM ASSEMBLIES

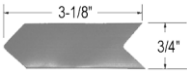
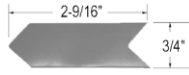
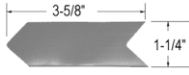
		
1. NEC21101538 14'	1. NEC21550430 14'	1. MTR06300497 14'

6.1.2.5: MISCELLANEOUS DOOR SEAL ACCESSORIES

<p>Outside Corner Tab</p> 	<p>Inside Corner Tab</p> 	<p>Flexible Corner Tab</p> 
<p>1. DOR1-13</p>	<p>1. DOR1-14</p>	<p>1. DOR1-15</p>
<p>Corner Tab Adhesive</p> 	<p>Edge Moulding Adhesive</p> 	<p>Quilted stainless steel overlay sheet</p> <p>Overlay sheet 48" x 112" x 22 Ga.</p>
<p>1. WHI58A-1</p>	<p>1. WHI58S-1</p>	<p>1. NEC21554811 48" x 110"</p>
<p>18" x 18" Reefer Gasket Corner Kit</p> 		
<p>1. NEC21551818 18" x 18"</p>		

6: Doors & Accessories

6.2 “New Cell” Swing Doors & Accessories

6.2.1: NEWCOURT™ “NEW CELL” COMPOSITE SWING DOOR

- * Environmentally friendly, recyclable polymer core.
- * Structural honey comb core design for lightweight/high strength
- * Impervious to moisture, no rotting & resists warping
- * Approximately 55% lighter than plymetal door

Part Number	Thickness	A	B	Outside Finish	Inside Finish
DOR3-25	.72"	49"	121"	.024" White aluminum	26 Ga. galvanized
DOR3-26	.72"	49"	110"	.024" White aluminum	20 Ga. galvanized

Note: Use Ferrule part number NEC618804 (1/2" x 5/8") to attach door hardware.

6.2.2: NEWCOURT™ “NEW CELL” DOOR SEALS & RETAINERS

.72" x 14' Retainer

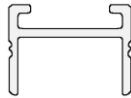

1. NEC6942071

14' Black Vinyl Seal



1. NEC6927771

14' Complete Assembly



1. NEC6927771ASSY

6.3 Gaskets & Frames

6.3.1: GASKETS (EPDM MATERIAL)

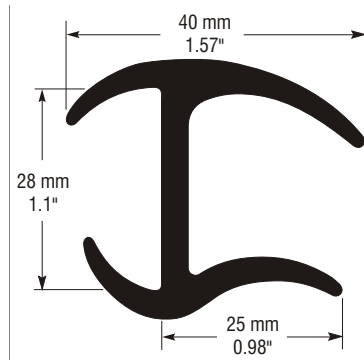

1. RB-06

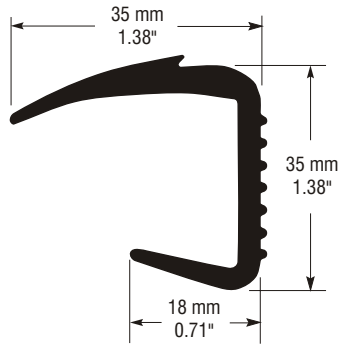

1. RB-03

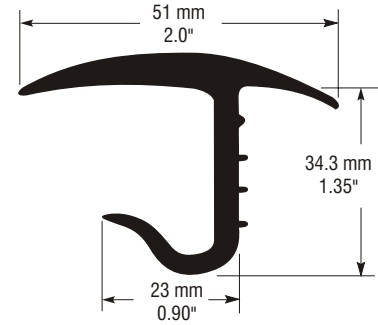

1. RB-04

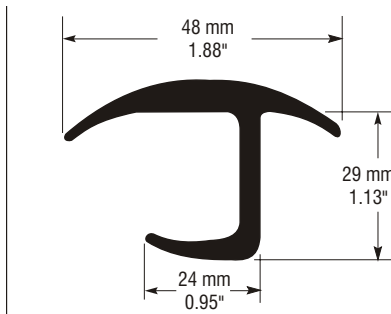

1. RB-05

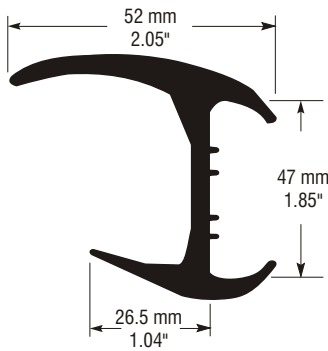

1. RB-07

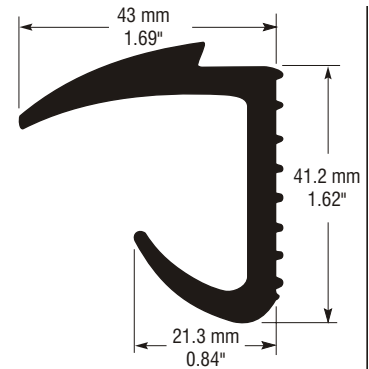

1. RB-11

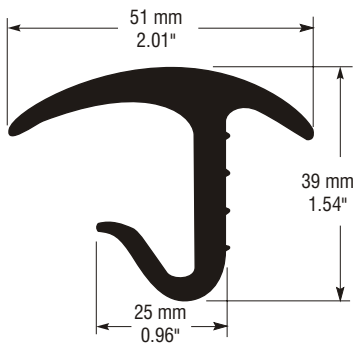

1. RB-12

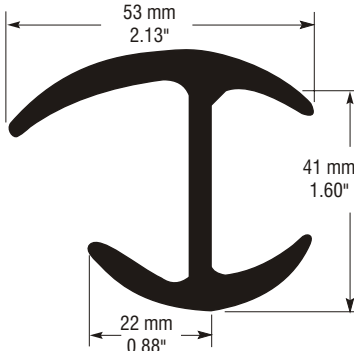

1. RB-42

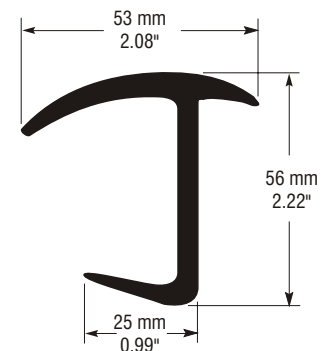

1. RB-43

6: Doors & Accessories

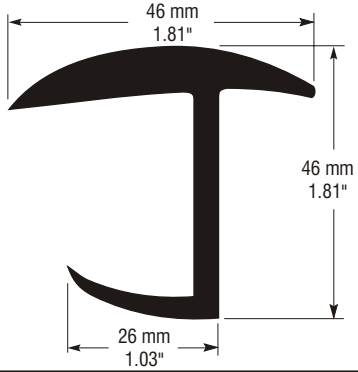

1. 1353

6.3.2: DOOR GASKET RETAINER STRIPS

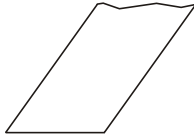

1" x 96"

1. 1734RETST
Matl: 20GA Galvanized Steel

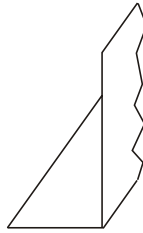

1/2" x 1" x 96"

1. 1734RETSTAN
Matl: 20GA Galvanized Steel

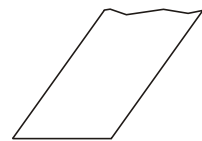

1" x 96"

1. 1734RETSTSS
Matl: 20GA Galvanized Steel

6.3.3: DOOR FRAMES

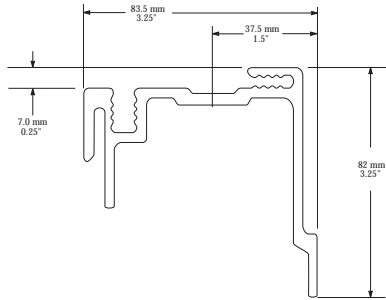

1. 39RFDF1398
Matl: PVC

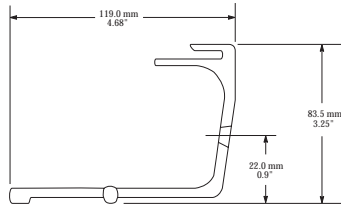

1. 39RFDF1400
Matl: PVC

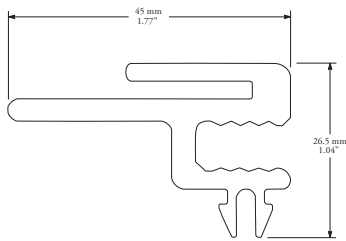

1. 40RF006454701
Matl: PVC

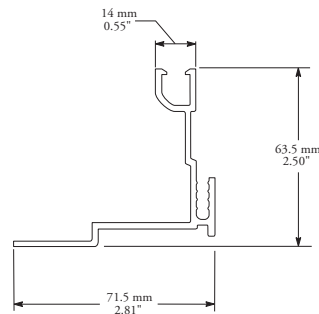

1. 40RF001564405
Matl: 6061-T6 Aluminum

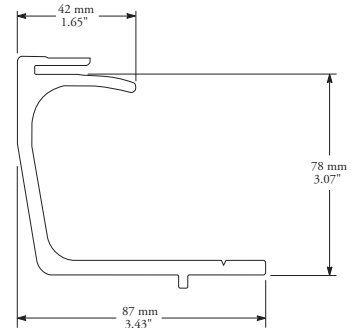

1. 40RF006455601
Matl: PVC

6: Doors & Accessories

6.4 Swing Door Locks & Accessories

6.4.1: WABASH REAR SWING DOOR LOCK ASSEMBLY

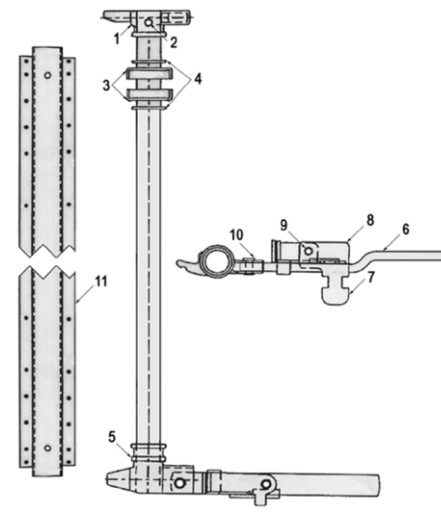
Part Number	Code	Description	Figure
WAB06301816	1	C/S upper lock rod cam	
WAB06301817	1	R/S upper lock rod cam	
WAB06301819	2	1/4" spring pin	
WAB06301830	3	Lock rod channel cap	
WAB06301829	4	1/8" thick thrust bearing	
WAB06301529	4	1/16" thick thrust bearing	
WAB06301530	4	1/4" thick thrust bearing	
WAB06301814	5	C/S lower lock rod cam	
WAB06301815	5	R/S lower lock rod cam	
WAB06301818	6	Door latch handle	
WAB06301821	7	C/S door latch tongue	
WAB06301822	7	R/S door latch tongue	
WAB06301823	8	C/S door latch lever	
WAB06301824	8	R/S door latch lever	
WAB06301820	9	Latch pin	
WAB06301540	10	3/8" rivet	
WAB06A01029	11	111.9" aluminum lock rod cover	
WAB06A00988	11	111.9" PPW aluminium lock rod cover	
WAB06301827	-	C/S S/S upper lock rod keeper	THESE PARTS ARE NEEDED IN THE ASSEMBLY BUT ARE NOT SHOWN IN THIS FIGURE
WAB06301828	-	R/S S/S upper lock rod keeper	
WAB06301826	-	S/S lower lock rod keeper	
WNCPI0621" x 120"	-	L & R beaing kit	

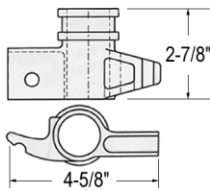
Lower Lock Rod Cam

curbside shown

- | | |
|----------------|-----|
| 1. WAB06301814 | C/S |
| 2. WAB06301815 | R/C |

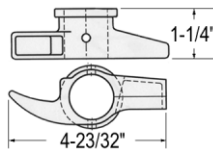
Upper Lock Rod Cam

curbside shown

- | | |
|----------------|-----|
| 1. WAB06301816 | C/S |
| 2. WAB06301817 | R/S |

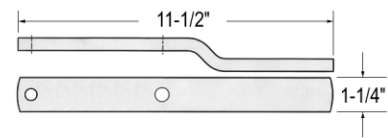
Door Latch Handle

- | | |
|----------------|--|
| 1. WAB06301818 | |
|----------------|--|

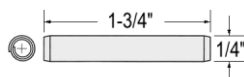
1/4" Spring Pin

- | | |
|----------------|--|
| 1. WAB06301819 | |
|----------------|--|

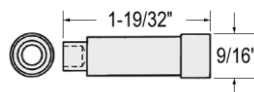
Security Latch Pin

- | | |
|----------------|-----|
| 1. WAB06301820 | S/S |
|----------------|-----|

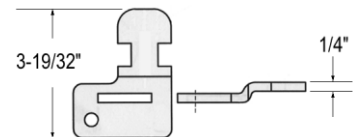
Door Latch Tongue

curbside shown

- | | |
|----------------|-----|
| 1. WAB06301821 | C/S |
| 2. WAB06301822 | R/S |

<p>Door Latch Lever</p> <p>curbside shown</p> <p>1. WAB06301823 C/S 2. WAB06301824 R/S</p>	<p>Handle & Latch Assembly</p> <p>-C = WAB06301821 & WAB06301818 -R = WAB06301822 & WAB06301818</p> <p>1. WAB06301825-C C/S 2. WAB06301825-R R/S</p>	<p>Lower Lock Rod Keeper</p> <p>1. WAB06301826 S/S</p>
<p>Lock Rod Thrust Bearing</p> <p>1-7/8" OD 1-11/32" ID</p> <p>1. WAB06301829 1/8" thick 2. WAB06301529 1/16" thick 3. WAB06301530 1/4" thick</p>	<p>Upper Lock Rod Keeper</p> <p>curbside shown</p> <p>1. WAB06301827 C/S S/S 2. WAB06301828 R/S S/S</p>	<p>Lock Rod Channel</p> <p>1. WAB06301830 S/S</p>
<p>Bearing Sleeve</p> <p>1. WNCPI062-1 L & R bearing kit</p>	<p>Lock Rod Cover</p> <p>1. WAB06A01029 Aluminum 2. WAB06A00988 PPW alum.</p>	<p>3/8" Rivet</p> <p>3. WAB06301540 S/S</p>

6.4.2: FRUEHAUF SWING DOOR LOCK ASSEMBLIES

6.4.2.1: FRUEHAUF REAR SWING DOOR LOCK ASSEMBLY

Part Number	QTY	Description	Item	Figure
FRUDCF3528-900	1	Kit		
FRUDCF3525-1	1	Handle	1	
FRUDCF3528-801	1	Universal lock rod	2	
FRUDCF3522-1*	2	Lock rod strap	3	
FRUDCF3527-1*	2	Wear plate	4	
FRUDCF3532-1	1	Handle bracket	5	
FRUDCF3531-1	1	Handle latch	6	
FRUDCF3524-1	1	Spacer	7	
FRUDCC7908-7*	1	Rivet 3/8" x 1-5/16"	8	
FRUDCC7908-8*	1	Rivet 3/8" x 1-1/2"	9	
FRUDCC7908-6*	1	Rivet 3/8" x 1-1/8"	10	
FRUWCF1376-1	2	Cam keeper	11	
FRUDCD0288-1	1	Handle strap	12	
FRUDCF3529-1	1	Cam	13	
FRUDCF3529-2	1	Cam	14	

* items not included in kit, for reference purposes only

Part Number	Qty	Description	Item	Figure
FRUDCF3528-800	1	Kit		
FRUDCF3528-801	1	Lock rod		
FRUDCF3529-1	1	Cam		
FRUDCD0288-1	1	Handle bracket		

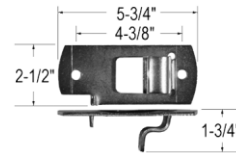
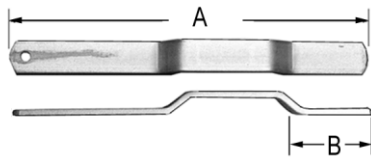

	A	B	1. FRUDCF3532-1	Handle bracket
1. FRUDCD0292-1	14-1/2"	4-3/4"		
2. FRUDCE8361-1	16-11/16"	6-5/16"		

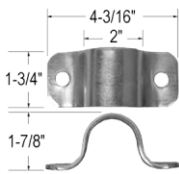

1. FRUDXA0227	Lock pin guide	1. FRUWCF1376-1	Keeper	1. FRUDCF3531-1	Handle latch
---------------	----------------	-----------------	--------	-----------------	--------------

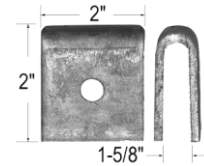
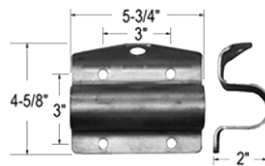
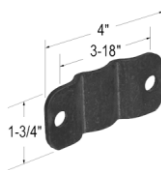

1. FRUDXA0228	Lock rod back plate	1. FRUDCF2139-1	Lock rod guide	1. FRUDCD0288-1	Handle strap
---------------	---------------------	-----------------	----------------	-----------------	--------------

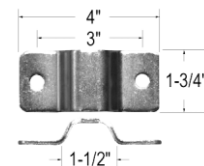
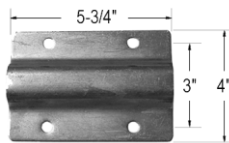
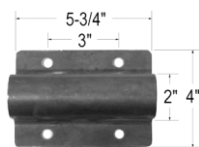

1. FRUDCF2136-1	Lock rod guide	1. FRUDCF2137-1	Lock rod guide	1. FRUDCF2138-1	Guide back plate
-----------------	----------------	-----------------	----------------	-----------------	------------------

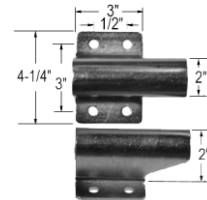
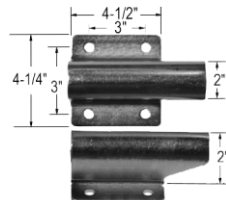
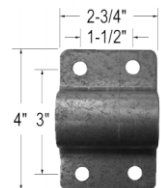

1. FRUDCE7834-1	.69" lock rod guide	1. FRUDCF3521-1	Guide back plate	1. FRUDCF3522-1	Guide back plate
2. FRUDCE7834-2	.75" lock rod guide				

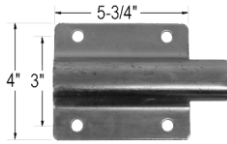

1. FRUDCF3526-1 Guide back plate

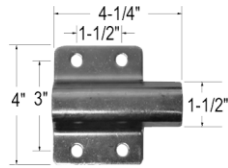

1. FRUDCF3527-1 Guide back plate



1. FRUDCF3524-1 Spacer



1. FRUDCC7908-9 Rivet A = 3/4"
 2. FRUDCC7908-1 Rivet A = 1-3/4"
 3. FRUDCC7908-6 Rivet A = 1-5/8"
 4. FRUDCC7908-7 Rivet A = 1-5/16"



1. FRUDCF3529-1 C/S cam lock
 2. FRUDCF3529-2 R/S cam lock

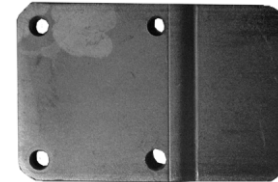

1. FRUDCF3520-1 Anti-theft plate

6.4.2.2: FRUEHAUF SWING DOOR COMPONENTS

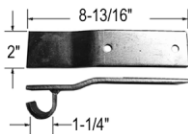

1. FRUDCF6797-1 Hinge assembly

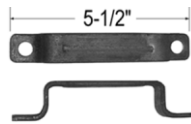

1. FRUWCE8339-1 Side door keeper

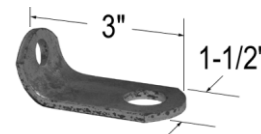

1. FRUDCE8363-1 Latch



1. FRUWCE8338-1 Hinge butt

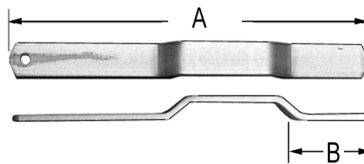







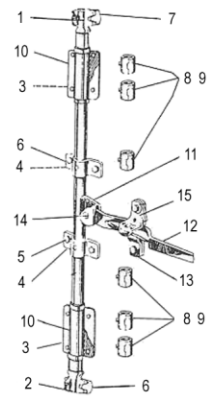

1. FRUDCE8361-1 Door handle
 A = 16-11/16"
 B = 6-5/16"

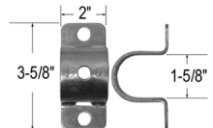
6: Doors & Accessories

6.4.3: MTR SWING DOOR LOCK ASSEMBLY & ACCESSORIES
6.4.3.1: MTR SWING DOOR LOCK ASSEMBLY

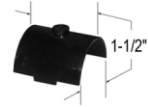
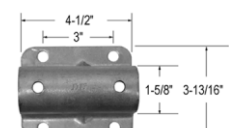
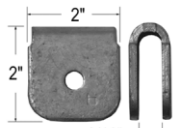
Part Number	Number	Description	Qty	Figure
MTR10080	1	RH cam	1	 <p>Right Hand Shown</p>
MTR10081	2	LH cam	1	
MTR10159-1	3	Bearing back plate	2	
MTR10160	4	Guide back plate	2	
MTR10163	5	Front guide	2	
MTR10364	6	LH keeper	1	
MTR10365	7	RH keeper	1	
MTR10556	8	1/2" Nylon bushing	6	
MTR10557	9	1/2" Nylon bushing	6	
MTR11028	10	Bearing bracket	2	
MTR22084	11	Handle hub	1	
MTR22182	12	Handle	1	
MTR22183	13	Handle retainer	1	
MTR22185	14	Bushing	1	
MTR22192	15	Latch	1	

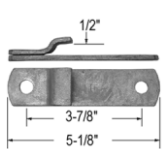
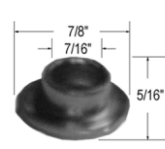
6.4.3.2: MTR SWING DOOR COMPONENTS

		
1. MTR10163 Front guide	1. MTR10159-1 Bearing back plate	1. MTR10160 Guide back plate
		
1. MTR10080 RH cam 2. MTR10081 LH cam	1. MTR10364 LH keeper 2. MTR10365 RH keeper	1. MTR10556 1/2 nylon bushing 2. MTR10557 1/2 nylon bushing
		
1. MTR11028 Bearing bracket	1. MTR22084 Handle hub	1. MTR22182 Handle
		
1. MTR22183 Handle retainer	1. MTR22185 Bushing	1. MTR22192 Latch

6.4.4: POWERBRACE (MINER) SWING DOOR LOCK ROD ASSEMBLY & ACCESSORIES







6.4.4.1: POWERBRACE (MINER) SWING DOOR LOCK ROD ASSEMBLY

Part Number	Number	Description	Qty	Figure
MTRDL-BU		Kit—No lock rod, standard cams	1	
MTRDLNH120LH		LH kit with lock rod, narrow header	1	
MTRDLNH120RH		RH kit with lock rod, narrow header	1	
MTR1064	1	Keeper	2	
MTR4043	2	LH cam	2	
MTR4044		RH cam	2	
MTR4207	3	Guide plate	2	
MTR4042	4	Half bushing	4	
MTR4005	5	Rod guide	1	
MTR4006	6	Half bushing	2	
MTR4012	7	Seal pin	1	
MTR4090	8	Handle	1	
MTR4208	9	Handle mount	1	
MTR4011	10	Seal plate	1	
MTR4049	11	Rivet 13/32" x 1-1/8"	1	
STL21644900	12	1" x 120" Galvanized pipe	1	
For narrow header use				
MTR4140	1	Keeper	1	
MTR4141	2	LH cam	1	
MTR4142		RH cam	1	

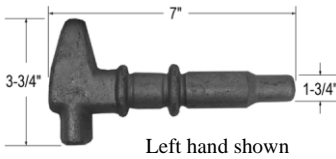
6.4.4.2: POWERBRACE (MINER) SWING DOOR COMPONENTS

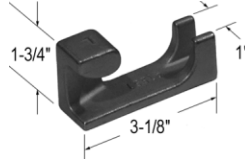
<p>Lock Rod and Strap Not Included</p>	<p>120" Galvanized Pipe with Handle attached Bottom Cam Attached Top Cam Sent Loose (Cut to Length)</p> <p>MIN4043/MIN4044 Cams</p>	
<p>1. MTRMC1166 Mid-camlock</p>	<p>1. MTRPDLNHTELHDG120LH LH 2. MTRPDLNHTELHDG120RH RH</p>	<p>1. MTR4004 Door guide</p>
<p>Left hand shown</p>	<p>Left hand shown</p>	<p>Left hand shown</p>
<p>1. MTR2091 LH cam 2. MTR2092 RH cam</p>	<p>1. MTR4043 LH cam 2. MTR4044 RH cam</p>	<p>1. MTR4153 LH cam 2. MTR4154 RH cam</p>

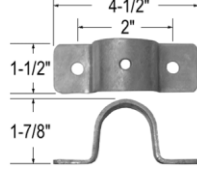
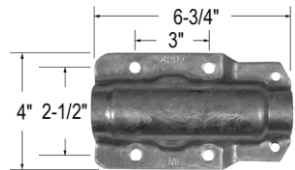
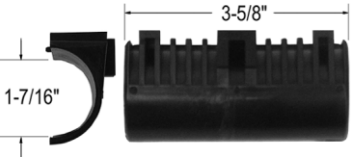
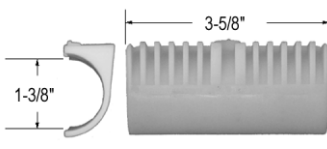
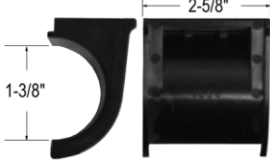
6: Doors & Accessories

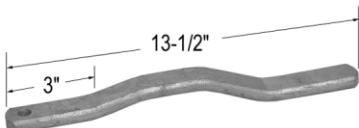
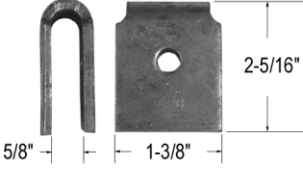
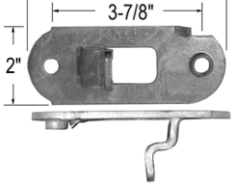
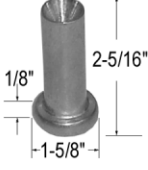
 <p>Left hand shown</p> <p>1. MTR2497 LH cam 2. MTR2498 RH cam</p>	 <p>1. MTR4054 Keeper</p>	 <p>Left hand shown</p> <p>1. MTR4155-7 LH keeper 2. MTR4156-7 RH keeper</p>
 <p>1. MTR1064 Keeper</p>	 <p>1. MTR4005 Rod guide</p>	 <p>1. MTR4207 Guide plate</p>
 <p>1. MTR4042 Half bushing</p>	 <p>1. MTR4007 Half bushing</p>	 <p>1. MTR4006 Half bushing</p>
 <p>1. MTR4012 Galv. seal pin 2. MTR4012-1 Seal Handle</p>	 <p>1. MTR4090 Galv. handle 2. MTR4090-1 Handle</p>	 <p>1. MTR4208 Galv. handle mount 2. MTR4208-1 Handle mount</p>
 <p>1. MTR4011 Galv. seal plate 2. MTR4011-1 Seal plate</p>	 <p>1. MTR4049Rivet 13/32" x 1-1/8"</p>	

6.4.5: BLOXWICH REAR DOOR HARDWARE

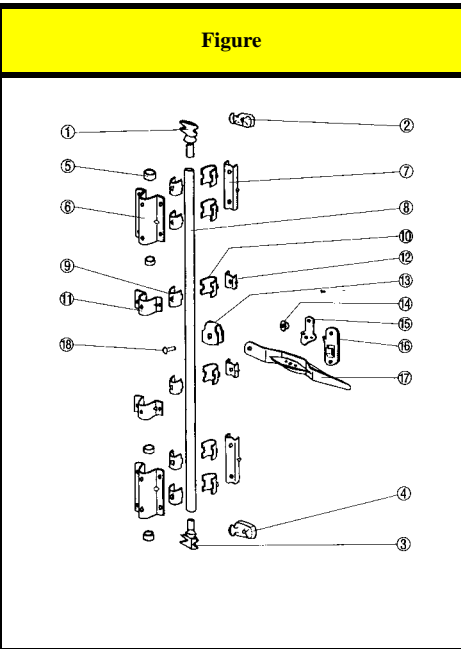
Item Number	Part No.	US	Description	Figure
1	BCP 10081	1	CAM L.H.	
2	BCP 10365	1	KEEPER L.H.	
3	BCP 10080	1	CAM R.H.	
4	BCP 10364	1	KEEPER R.H.	
5	BCP 10178	4	ANTI RACK RING	
6	BCP 11028	2	BEARING BRACKET OUTER LARGE	
7	BCP 10159/1	2	BEARING BRACKET INNER LARGE	
8	N.D.	1	TUBE 34 mm dia X 3.2 thk	
9	BCP 10557	6	UPPER SHORT SPLIT BUSH	
10	BCP 10556	6	LOWER SHORT SPLIT BUSH	
11	BCP 10163	2	BEARING BRACKET OUTER SMALL	
12	BCP 10060	2	BEARING BRACKET INNER SMALL	
13	BCP 22084	1	HANDLE HUB	
14	BCP 22185	1	BUSH	
15	BCP 22192	1	CATCH	
16	BCP 22183	1	RETAINER PLATE	
17	BCP 22162	1	HANDLE	
18	BCP 10038/1	1	RD/RIVET 9.5 mm x 28.5 mm	

6.4.6: BLOXWICH REAR DOOR HARDWARE

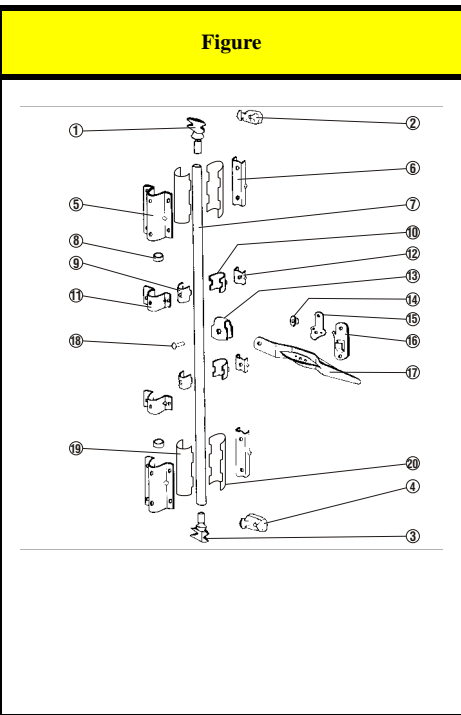
Item Number	Part No.	US	Description	Figure
1	BCP 10081	1	CAM L.H.	
2	BCP 10153	1	KEEPER L.H.	
3	BCP 10080	1	CAM R.H.	
4	BCP 10152	1	KEEPER R.H.	
5	BCP 10983/3	2	BEARING BRACKET OUTER LARGE	
6	BCP 10159/1	2	BEARING BRACKET INNER LARGE	
7	N.D.	1	TUBE 34 mm dia X 3.2 thk	
8	BCP 10176	2	ANTI RACK RING	
9	BCP 10557	6	UPPER SHORT SPLIT BUSH	
10	BCP 10556	6	LOWER SHORT SPLIT BUSH	
11	BCP 10163	2	BEARING BRACKET OUTER SMALL	
12	BCP 10160	2	BEARING BRACKET INNER SMALL	
13	BCP 22084	1	HANDLE HUB	
14	BCP 22185	1	BUSH	
15	BCP 12229	1	CATCH	
16	BCP 22183F	1	RETAINER PLATE	
17	BCP 22182	1	HANDLE	
18	BCP 10038/1	1	RD/RIVET 9.5 mm x 28.5 mm	
19	BCP 10555	2	UPPER MEDIUM SPLIT BUSH	
20	BCP 10554	1	LOWER MEDIUM SPLIT BUSH	

6.5 Swing Door Hinges

6.5.1: WABASH DOOR HINGES

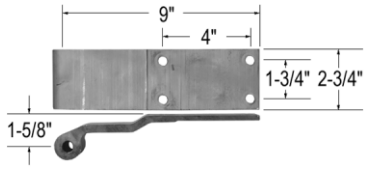
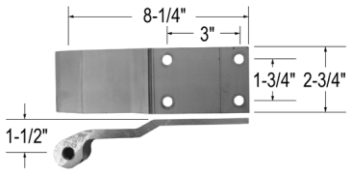
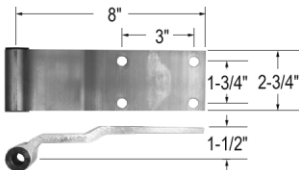
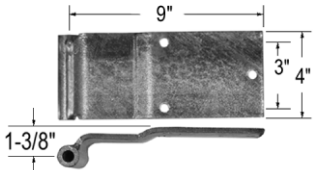
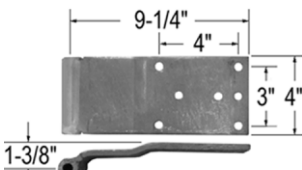
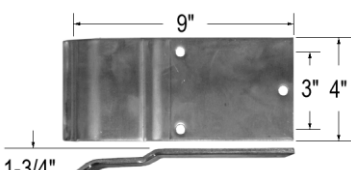
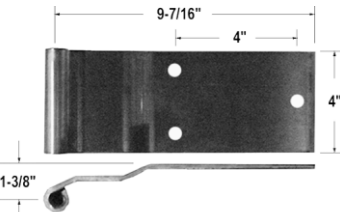
		
<p>1. WAB06300291 4 Hole alum.</p>	<p>1. WAB06301272 4 Hole alum.</p>	<p>1. WAB06301527 Alum. P1089</p>
		
<p>1. MTRH1081-3 3 Hole steel</p>	<p>1. WABRHD100014 7 Hole steel</p>	<p>1. WAB06S01838 3 Hole S/S</p>
		
<p>1. WAB06S03293 S/S</p>		

6.5.2: FRUEHAUF DOOR HINGES & ACCESSORIES

<p>1. FRUDBA1583-1 3 Hole alum.</p>	<p>1. FRUBCF4678-1 4 Hole alum.</p>	<p>1. FRUDCF8627-1 3 Hole alum.</p>
<p>1. FRUDCF3980-1 4 Hole steel 2. PEN60-04 4 Hole steel</p>	<p>1. FRUBCE3439-1 4 Hole steel</p>	<p>1. FRUDCB7039-1 3 Hole steel</p>
<p>1. FRUDCE8681-1 4 Hole steel 2. PEN60-02 4 Hole steel</p>	<p>1. FRUDCF1892-1 6 Hole steel</p>	<p>1. FRUDCF0451-1 6 Hole steel</p>
<p>1. FRUDCE7825-1</p>	<p>1. FRUDCF8423-1 3 Hole steel</p>	<p>1. FRUDCF4222-1 6 Hole steel</p>
	<p>Nut for FRUDXA0687</p>	<p>Bolt for FRUDXA0687</p>
<p>1. FRUDXA0687 Steel Reefer 2. FLT022-00013 Steel Reefer</p>	<p>1. FRUDXA0686-PK1 A = .75" 2. FRUDXA0686-PK2 A = .50"</p>	<p>1. FRUDXA0696-PK1 A = 7/8" 2. FRUDXA0696-PK2 A = 1-1/8"</p>

6: Doors & Accessories

6.5.3: OTHER MANUFACTURER'S SWING DOOR HINGES & ACCESSORIES

6.5.3.1: GREAT DANE STYLE SWING DOOR HINGES & ACCESSORIES

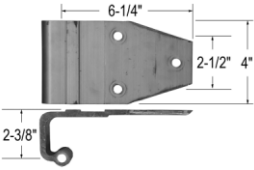
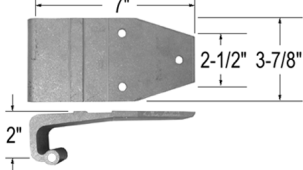
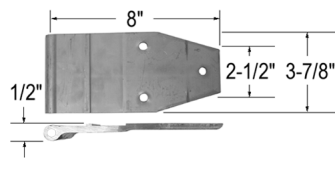
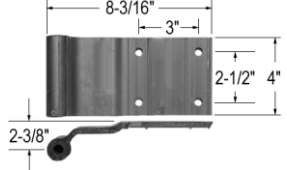
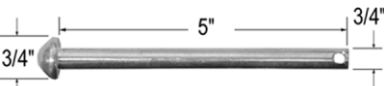
 <p>Dry Freight</p>	 <p>Reefer</p>	
<p>1. GDA08138 3 Hole alum.</p>	<p>1. GDA08206 3 Hole alum.</p>	<p>1. GDA022-01007 3 Hole alum. 2. FLT022-01007</p>
	 <p>3/8" x 5"</p>	
<p>1. GDA31800904 4 Hole alum.</p>	<p>1. GDA44573 Hinge pin</p>	



6.5.3.2: POWERBRACE (MINER) STYLE SWING DOOR HINGES & ACCESSORIES

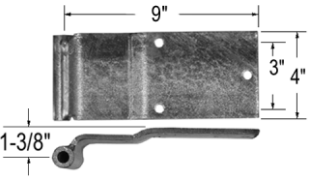
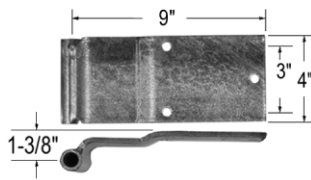
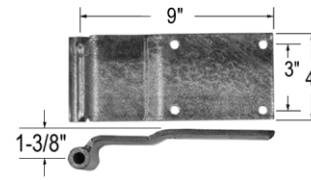
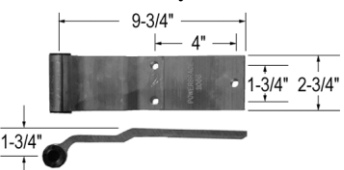
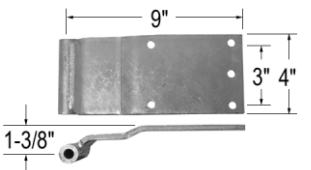

<p>Miner Style</p>  <p>3 Hole galvanized steel</p>	<p>Miner Style</p> 	<p>Miner Style</p> 
<p>1. MTRH1060-3 5/16" thick 2. MTRH1081-3 1/4" thick 3. MTRH1081-3Z 1/4" thick w/ zerk</p>	<p>1. MTRH1078-3 3 Hole galv. steel</p>	<p>1. MTRH1060-4 4 Hole steel 2. MTRP108550 4 Hole aluminum</p>
<p>Miner Style</p> 	<p>Miner Style</p> 	
<p>1. MTRP108630 3 Hole aluminum with nylon insert</p>	<p>1. PEN60-09 5 Hole Steel 2. FLT023-00559</p>	

6.5.3.3: STRICK STYLE SWING DOOR HINGES & ACCESSORIES

<p>1. STRAA33C-0106-01 3 Hole steel</p>	<p>1. FLT021-00025 3 Hole steel</p>	<p>1. STR6A-23557 4 Hole steel</p>
<p>Replaces #6A-22679</p> <p>1. FLTFE021-00006 3 Hole steel</p>	<p>1. FLT022-01003 3 Hole alum</p>	<p>1. STRMDRHBWELD325 Hinge butt</p>

6.5.3.4: TRAILMOBILE STYLE SWING DOOR HINGES & ACCESSORIES

<p>Replaces #515-10-61A</p> <p>1. TMB515-10-61A 3 Hole steel</p>	<p>Replaces #515-10-73A</p> <p>1. TMB515-10-73A 3 Hole steel</p>	<p>Replaces #515-10-78-1</p> <p>1. TMB21041433 4 Hole alum</p>
<p>Replaces #515-A10-13</p> <p>1. TMB515-A10-13 4 Hole steel</p>	<p>Replaces #515-11-29</p> <p>1. TMB15-11-29 Hinge butt</p>	<p>Replaces #515-11-37</p> <p>1. TMB515-11-37 Hinge but</p>
<p>Replaces #515-12-13</p> <p>1. TMB515-12-13 Hinge pin</p>	<p>Replaces #515-12-23</p> <p>1. TMB515-12-23 Hinge pin</p>	

6.5.3.5: MISCELLANEOUS SWING DOOR HINGES & ACCESSORIES

<p>MONON Style</p> <p>1. MONDH032282 3 Hole alum</p>	<p>PINES Style</p> <p>1. PNEAE54111 3 Hole alum</p>	<p>STOUGHTON Style</p> <p>1. STO04-08316-000-00 4 Hole alum</p>
---	--	--

6: Doors & Accessories

<p>UTILITY Style</p>	<p>UTILITY Style</p>	
<p>1. UTI1-4950-071 3 Hole steel</p>	<p>1. UTI3-6101-08 3 Hole alum</p>	<p>1. BCP 10045</p>
<p>1. BDP 11026</p>	<p>1. BDP 10402 / HF 900</p>	<p>1. 21H702 Press Type Door Hinge</p>
<p>1. 21HF004 Forging Type Door Hinge</p>	<p>1. 86RFHIN5 Door Gear - Hinge</p>	<p>1. 86RFHIN6 Door Gear - Hinge</p>
<p>1. 21CHPN-001/1 Hinge Pin</p>	<p>1. 21L2220 Bloxwich Hinge Lug</p>	

6.6 Swing Door Hinge Butts & Hinge Pins

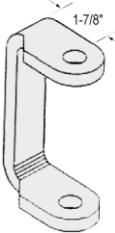
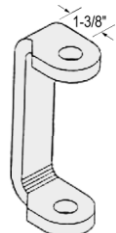
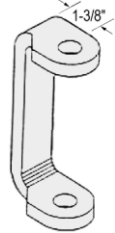

6.6.1: WABASH SWING DOOR HINGE BUTTS

	1-7/8" Offset		1-3/8" Offset		1-3/8" Offset
1. WAB06300556	2.75" S/S	1. WAB06300297 2. WAB06300588	3" Steel 3" S/S	1. WAB06300431	4" S/S

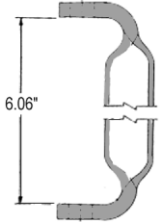
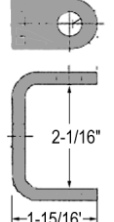
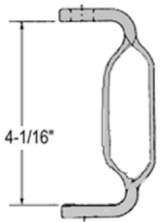
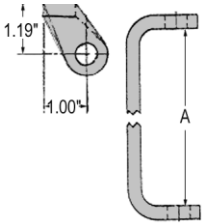
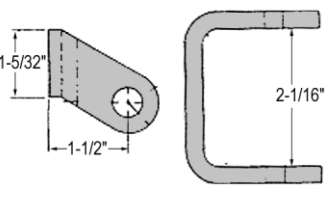
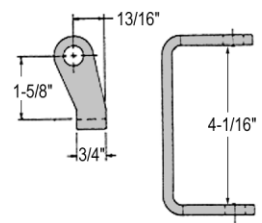
6.6.2: FRUEHAUF SWING DOOR HINGE BUTTS



	6" Steel		2" Steel		4" Steel
1. FRUWCF2456-1	6" Steel	1. FRUWXA0562-1	2" Steel	1. FRUWCE9567-1	4" Steel
	A = 4" Steel A = 6" Steel		2" Steel		4" Steel
1. FRUWCF3981-1 2. FRUWCF3981-2	A = 4" Steel A = 6" Steel	1. FRUWUB1513-1	2" Steel	1. FRUWCF0321-1	4" Steel

6.6.3: OTHER MANUFACTURER'S SWING DOOR HINGE BUTTS

	4" Steel		4" Steel		Steel Galvanized
1. FLT023-00641	4" Steel	1. FLT023-00664	4" Steel	1. MTRHB1156-6-1 2. MTRHB1156-6-5	Steel Galvanized

6: Doors & Accessories

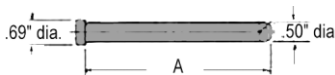
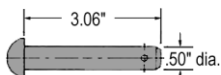
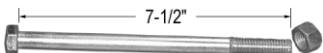
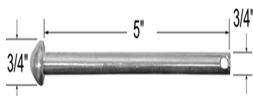
6.6.4: SWING DOOR HINGE PINS

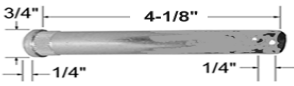
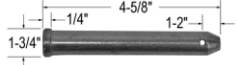
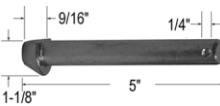
<p style="text-align: center;">DORSEY Style</p>  <p style="text-align: center;">1/2" x 4"</p> <p>1. FLT997-98022 Steel</p>	<p style="text-align: center;">FRUEHAUF</p>  <p style="text-align: center;">A</p> <p>1. FRUWCE7812-1 A = 5" Steel 2. FRUWCE7812-2 A = 7" Steel</p>	<p style="text-align: center;">FRUEHAUF</p>  <p>1. FRUWXA0605-PK1</p>
<p style="text-align: center;">FRUEHAUF</p>  <p>1. FRUWCE7812-902 Steel 5 per kit</p>	<p style="text-align: center;">GREAT DANE Style</p>  <p>1. GDA44573 3/8" x 5"</p>	<p style="text-align: center;">MINER Style</p>  <p>1. MTRHP1054-12</p>
<p style="text-align: center;">MINER Style</p>  <p>1. MTRHP1054-9 S/S</p>	<p style="text-align: center;">TRAILMOBILE Style</p>  <p>1. TMB515-12-13 5/8" x 4-1/8"</p>	<p style="text-align: center;">TRAILMOBILE Style</p>  <p>1. TMB515-12-23</p>
<p style="text-align: center;">WABASH</p>  <p>1. WAB06S00938 1/4" S/S</p>		

6.6.5: CONTAINER DOOR TIES

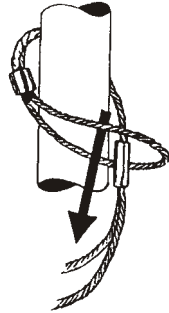

1. Wrap around bar.
2. Feed end into small loop.
3. Slip small loop over main ferrule.



4. Push sliding ferrule along the tie until loop is tight.

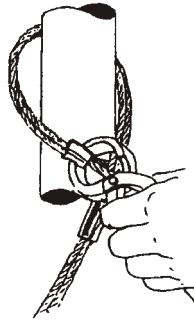

5. Pinch ferrule firmly onto the wire rope so that it will not slip back, taking care not to cut into either rope or ferrule.









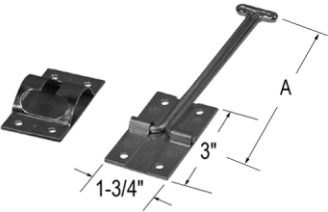
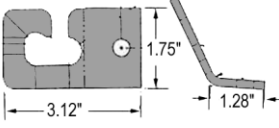
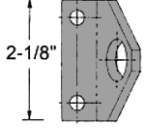
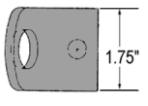

6. Job done!

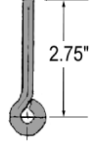



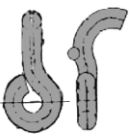
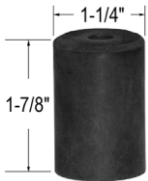
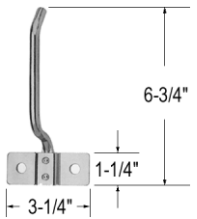
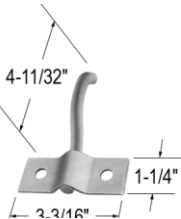
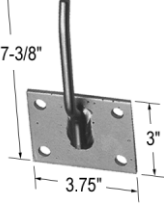

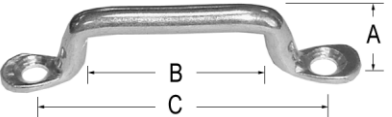
1. 84DT

6: Doors & Accessories

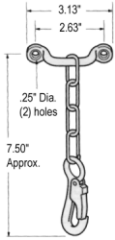
6.7 Swing Door Holdbacks & Accessories

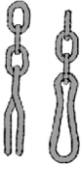
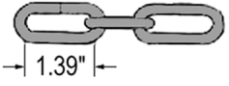
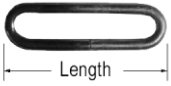
		
1. POL9 A = 4" 2. POL8 A = 6" 3. 9F Holdback only	1. FRUDCF5691-1 R/S 2. FRUDCF5691-2 C/S	1. FRUDCE7835-1
		
1. FRUDCF3523-1	1. FRUXCB9693-PK1	1. FRUDUB6643-1
		
1. FRUXCF2751-1	1. MTR06S01194 Galv.	1. MTR06300015
		
1. MTRA1300003 Galv.	1. FRUXCD0262-1	1. FRUDCF8141-1 Door stop
		
1. EBH6602-50 Hold back post	1. EBH6603-50 Hold back post	1. FLT022-00070 Hold back post
HD Footman Loop 	Footman Loop 	
1. EBH9611 Cast 2. POL55-201 S/S	1. WABA1300018 A = 1/2" B = 1-3/8" C = 2-1/8" 2. FRUXAS1009-1 A = 9/16" B = 1-5/8" C = 2-5/8" 3. WABA1300017 A = 5/8" B = 2-1/8" C = 3-1/8" 4. FLT021-00043 A = 3/4" B = 1-5/8" C = 2-5/8"	

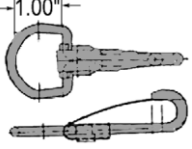
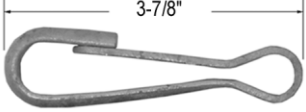
6: Doors & Accessories

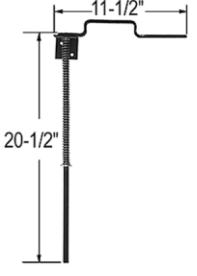
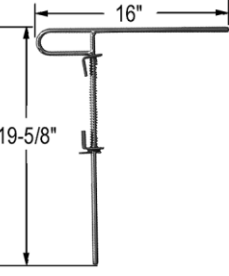
 <p>1. FLT021-00051</p>	 <p>1. FRUDXA0705-2 Chain</p>	 <p>1. FRUDCF3585-2 Chain</p>
 <p>1. FRUDCF5927-2 Chain</p>	<p>Link</p>  <p>1. FRUDCC7478-1 1" Link 2. EBH6601-2 2" Link 3. EBH6601-3 4" Link 4. EBH6601-4 6" Link</p>	 <p>1. FRU525461 Chain & snap</p>
 <p>1. WAB06300576 Chain & snap</p>	 <p>1. FRUDCF2758-1 Chain snap</p>	 <p>1. MTR06300058 1/2" Galv. Steel</p>
 <p>1. MTR06300059 7/16"</p>	<p>Wabash Reefer Hold Back</p>  <p>1. WAB06300094 Spring style</p>	<p>Reefer Hold Back</p>  <p>1. DORMDRHBREEF Spring style</p>

6.8 Door Seals & Locks

6.8.1: HIGH SECURITY SEAL

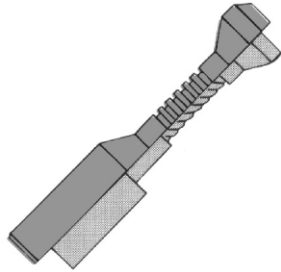

The core is seal is made of metal. The core has a diameter of 18 mm (0.7 inch), which makes it impossible to knock the seal through the fittings of the container. The core is cast into a shock-proof plastic material. The exterior diameter of the lock is 19 mm (0.8 inch).



Your name will be stamped in dark blue print on one side of the cylinder (max. 9 letters), and a consecutive 7-digit number on the other side.
Barcoding and unique company logos can also be engraved by special laser technique at an additional charge.

1. Construction

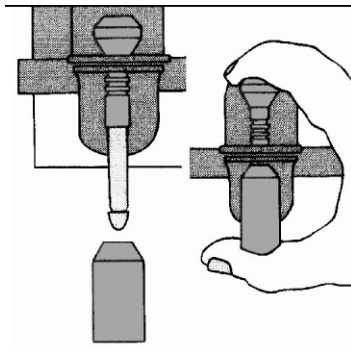

The locking bar and the cylinder are easily locked by a slight pressure by the hand and a distinct click is heard. The locking mechanism of each single seal has been tested electronically. The locking mechanism has been greased for anti-corrosion, which also secures an easy locking.

1. Locking

COLORS: The seals are available in blue, red, green, yellow, grey and white. Orders for a minimum quantity of 50,000 seals can be delivered in your special color combination.

1. Name and Number

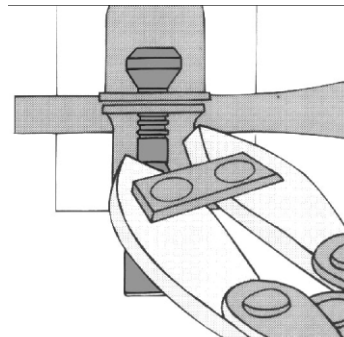

The seal is opened by a 24-inch bolt cutter.

1. Opening

6.8.2: HIGH SECURITY LOCK

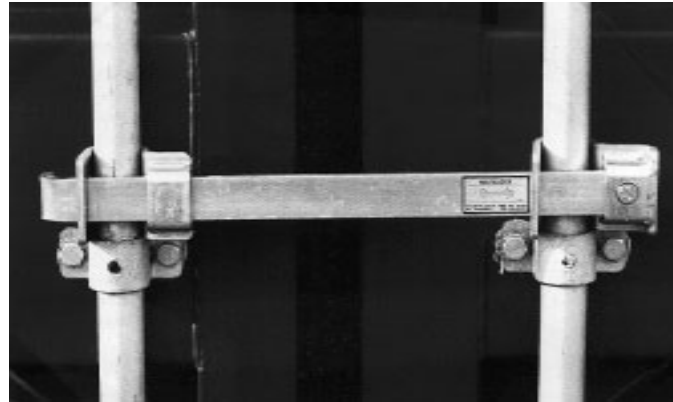

NAVALOCK®MK V provides the highest degree of antitheft security available today, combined with an approved sealing feature. It pays for itself by reducing the number of insurance claims, the cost of processing them and by eliminating the heavy penalties imposed by some Customs. NAVALOCK®MKV is the first of its kind since the introduction of containers into the shipping world. Easy to fit, no special skills or tools are required, its robust design fits most standard containers. It conforms to U.S. Customs requirements and is certified as a High Security Seal. The heavy locking bar (10 x 32 mm) make breaking into the container difficult. The breakload is over 3.5 tons, as witnessed by A.B.S. and N.K. Classification Societies. It resists cutting by double lever shears; breaking by hammer, crowbar, or other crude tools.

6: Doors & Accessories

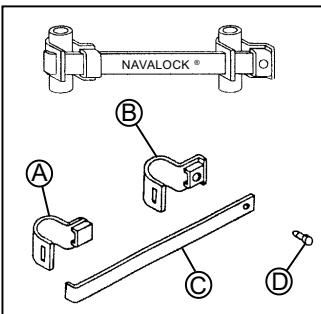

Fig. 1

Installation

- A. Insert the U shaped Gripping Bracket (Fig. 1A) behind one of the inner rods of the container doors and about half way up from the bottom of the container.
- B. Insert the U shaped Locking Mechanism Assembly Bracket (Fig. 1B) behind the adjacent inner rod of the opposite door and facing the Gripping Bracket.
- C. Insert the Sliding Locking Bar (Fig. 1C) through the Gripping Bracket, across to, and engaging into the Locking Mechanism Assembly Bracket. Check to make sure that the holes of the Locking Mechanism Assembly Bracket and the Sliding Locking Bar are aligned. Adjust if necessary by slightly moving the Sliding Locking Bar, or removing it, and rotating 180 degrees.
- Note: The bent part of the bar must face the door.
- D. Insert and push in the Locking Pin (Fig. 1D) by hand into the hold of the Locking Mechanism Assembly Bracket, making sure that it passes through the hole in the Sliding Locking Bar, until the pin head is flush with the casing. The pin fits distinctively as it grips into the mechanism, permanently locking, securing and sealing the container doors. This concludes the fitting procedure of the NAVALOCK MK V Security System.

Removal & Technical Specifications

- A. Removal of the NAVALOCK MK V is accomplished by cutting the Sliding Locking Bar, which is conveniently done by a hand-held power-driven disc. This tool is widely available and this cutting procedure can be carried out at the container terminal or receiver's warehouse.
- B. Standard NAVALOCK MK V locking range is for container doors where the maximum pitch of the inner door rods is 50 mm (center to center). Extra long locks are available by special order. Please contact your local representative.
- C. The main components of the NAVALOCK MK V construction are 10 mm thick, which is nearly double and sometimes triple that of the container panels or roof structure. They also exceed thicknesses of most of the locking fittings.
- D. The NAVALOCK MK V comes packed in carton boxes containing one set each. The total weight per standard length set is 2.05 kg and per carton weight is 10.5 kg accordingly.

1. T74NLMKV

6.8.3: RAILSEAL

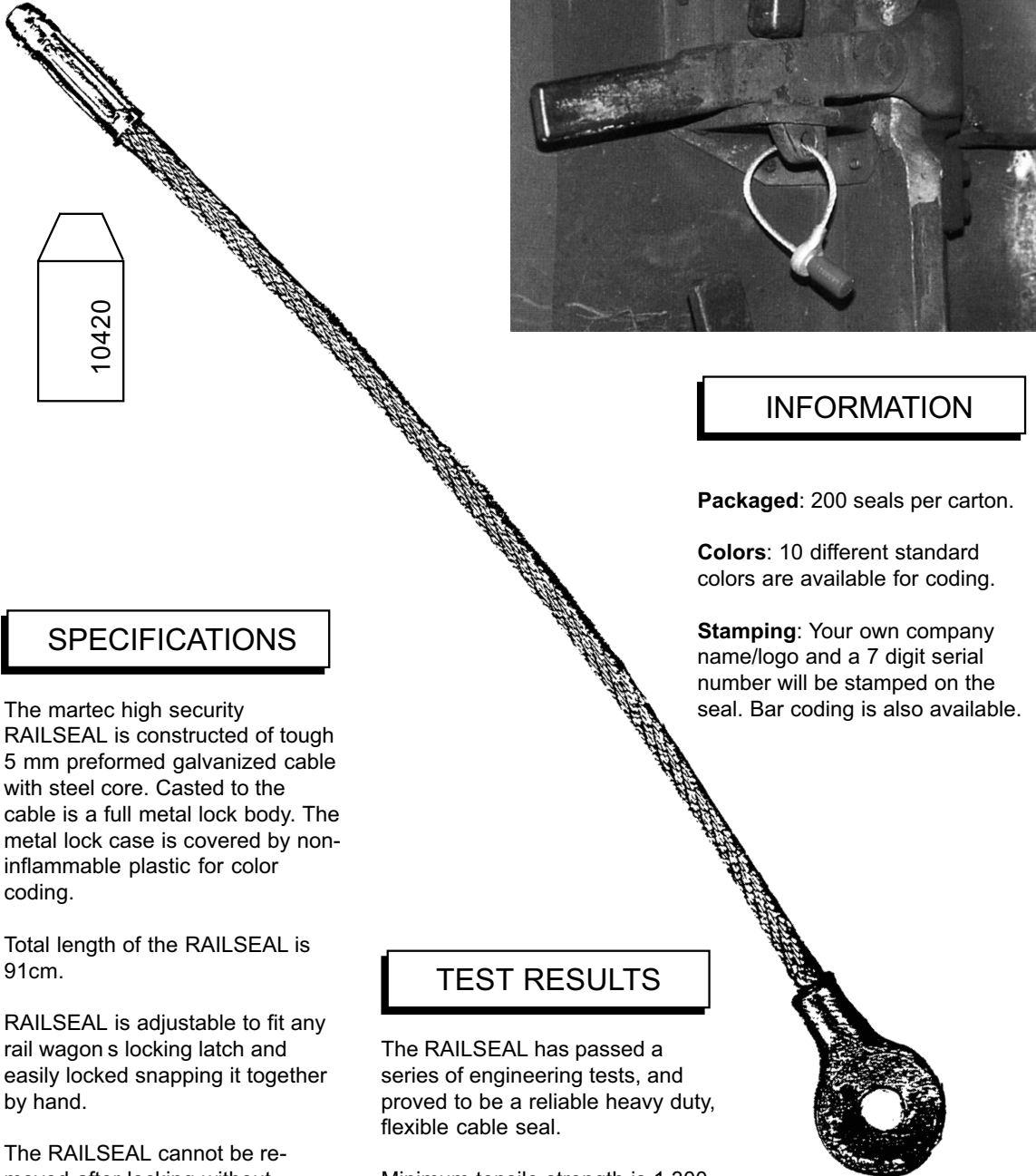

SPECIFICATIONS

The martec high security RAILSEAL is constructed of tough 5 mm preformed galvanized cable with steel core. Casted to the cable is a full metal lock body. The metal lock case is covered by non-inflammable plastic for color coding.

Total length of the RAILSEAL is 91cm.

RAILSEAL is adjustable to fit any rail wagon s locking latch and easily locked snapping it together by hand.

The RAILSEAL cannot be removed after locking without revealing evidence of tampering.

TEST RESULTS

The RAILSEAL has passed a series of engineering tests, and proved to be a reliable heavy duty, flexible cable seal.

Minimum tensile strength is 1.300 kilos.

INFORMATION

Packaged: 200 seals per carton.

Colors: 10 different standard colors are available for coding.

Stamping: Your own company name/logo and a 7 digit serial number will be stamped on the seal. Bar coding is also available.

6.8.4: CABLE SEAL

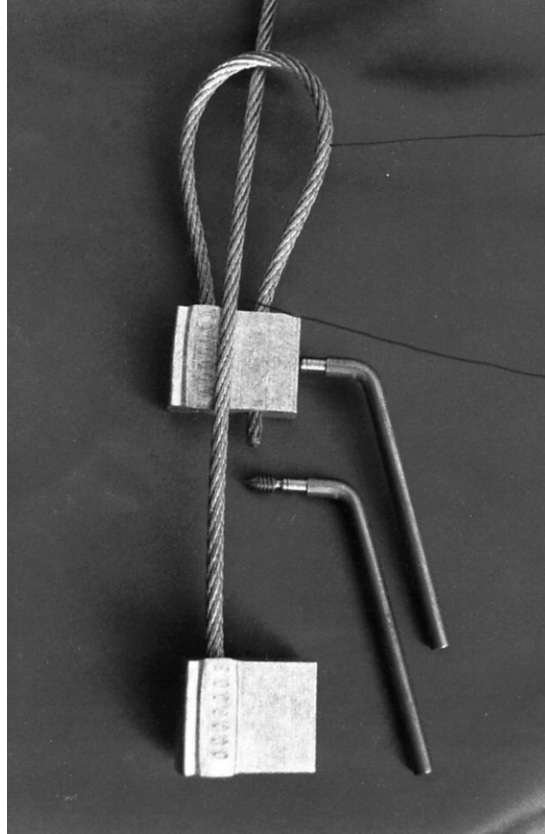

These units are ruggedly constructed with solid block aluminum case and strong 9-inch steel cable (longer lengths available by special request). A positive-locking hidden threaded screw locking device is furnished with each unit. When tightened securely, the lock screw is then recessed and holds cable securely against removal. When locked, the cable can withstand over 4000 lbs. of pull pressure. Handle of the locking device must be broken off and disposed of. The cable seal cannot be removed without using bolt cutters and is ideal for standard storage containers, railroad car doors and tank cars.

Cable seals come with your name or initials (no more than 7 letters) and consecutive numbering on each seal free of charge.

1. 69MINICAB

6.8.5: FLAT METAL SEAL



This seal is our basic flat metal strip seal, which has been tested and approved by leading shippers, underwriters and governmental agencies.

The Premier Seal is the most basic form of tamper-resistant seals, with sturdy crimped sides and strong spring snap. It seals itself quickly and easily and requires no punches or presses. It is a sure signal that a shipment has been delivered intact and as loaded. It allows protection at low-level cost and saves time and money in your warehouses and packaging facilities.

Included in the low price are your name or initial (up to 15 letters) and consecutive numbering embossed on each seal.

Different colors, changes in numbering or lettering are also available.

1. 69PREMSEAL

6.8.6: GLOBE SEAL

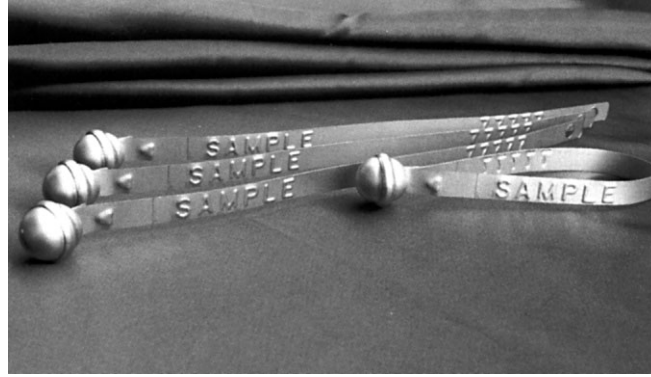

The patented Globe Seal provides sure protection for shipments in transit. Once the two spring rings click shut the Globe Seal cannot be resealed.

The Globe Seal is an immediate and reliable indicator that goods and materials are received exactly as shipped.

Your name or initials (no more than 18 letters) and consecutive numbering are embossed on each seal free of charge.

Different colors, extra lettering or changes in numbers are an extra fee.

1. 69GLOBE

6.8.7: PLASTIC CLIP SEAL

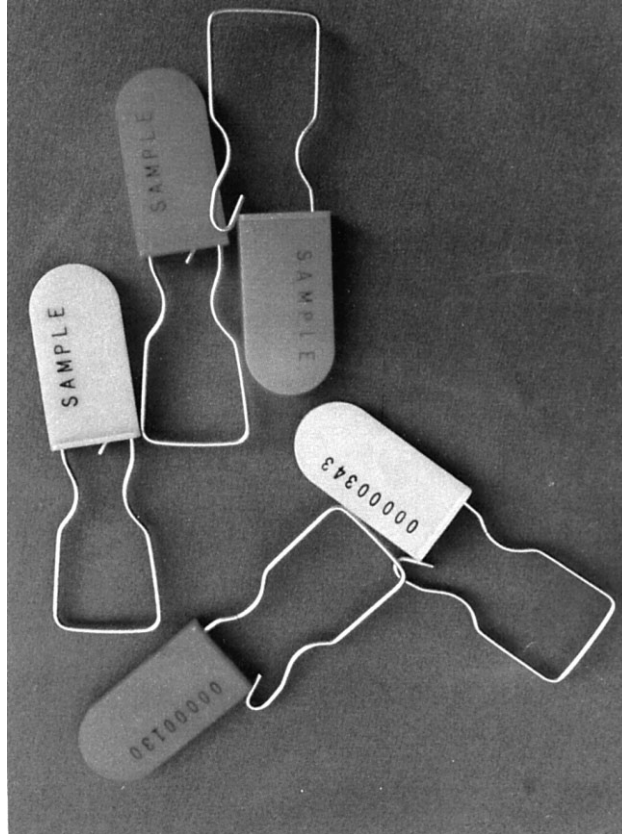

The Plastic Clip Seal provides instant identification of tampering at penny costs. With an intact plastic seal, tampering is less likely to occur since it cannot go undetected.

The seals are self-locking with just a push of a finger and once closed cannot be opened without being broken or cut. Available in the color of your choice for visibility, the plastic padlock seal is ideal for sealing utility or other meters, switches, containers, medical items, instruments and valves.

The tough plastic body and wire hasp (stainless steel hasp also available), resist rust and corrosion. The Plastic Clip Seals are inexpensive, lightweight, and imprinted with your company name or coding at no additional cost to you. Free sequential numbering is also available to identify seals that may have been tampered with, then replaced.

Your shipment is worth the few pennies to maximally protect your valuables,

1. 69DPS

6.9 Todco Roll-Up Doors, Door Panels & Accessories

6.9.1: EXPLODED VIEW OF TODCO 3/4" DRY FREIGHT DOOR

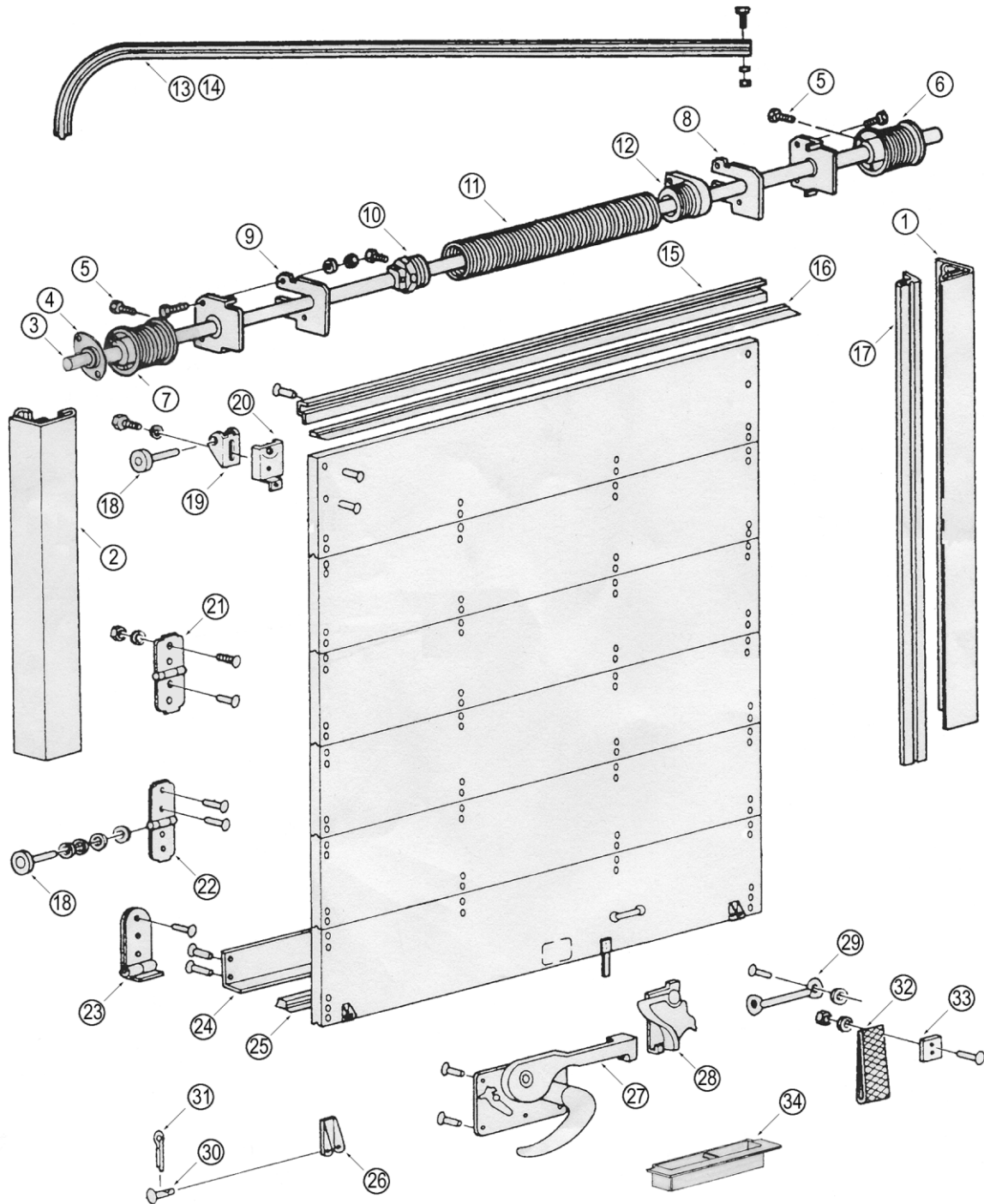

6: Doors & Accessories

6.9.2: DETAIL OF TODCO 3/4" DRY FREIGHT DOOR

Item	Part Number	Description
1	TOD49014-1	C/S vertical track
2	TOD49014-2	R/S vertical track
3	TOD51037	Counter balance shaft 90"
	TOD51037-3060	Counter balance shaft 95-5/8"
4	TOD51038	Bearing assembly
5	TOD80300-2414	Hex head set screw—3/8" x 7/8"
6	TOD59129-1	C/S cable drum
7	TOD59129-2	R/S cable drum
8	TOD51036-1	C/S spring angle bracket
9	TOD51036-2	R/S spring angle bracket
10	TOD51043	Spring anchor plug 1-3/4" ID
11	TOD51042	Spring 1-3/4" ID x 57"
12	TOD59158	Winding slug 1-3/4" spring
13	TOD49702-1	C/S horizontal track
14	TOD49702-2	R/S horizontal track
15	TOD61403	Retainer head seal
16	TOD61402	Head seal
17	TOD61390	Side seal 115"
18	TOD61174	1" Rollers
19	TOD69431	Top hinge slide
20	TOD69432	Top hinge base
21	TOD61196	Center hinges
22	TOD69035	End hinges
23	TOD61352	Bottom hinges
24	TOD61191-90	Bottom angle 90"
	TOD61191-95	Bottom angle 95"
25	TOD80840-90	Bottom seal 90"
	TOD80840-96	Bottom seal 96"
26	TOD61204	Cable anchor
27	TOD69571	Security lock
28	TOD69572	Keeper Assembly
29	TOD61401	Handle
30	TOD61206	Cable pin
31	80401-316	Cotter pin—3/32" x 1"
32	TOD80844-XX	Pull strap (see Section 2.9.5)
33	TOD69832	Pull strap retainer
34	TOD69341	Latch box
35	TOD29013-15x90	Top panel (see Section 2.9.4.1)
36	TOD29014-11X90	Intermediate panel (see Section 2.9.4.2)
37	TOD29016-11X90	Bottom panel (see Section 2.9.4.3)

6.9.3: TODCO & TODCO STYLE ROLL-UP DOORS

6.9.3.1: TODCO & TODCO STYLE 3/4" LIGHT GRAY PLASTIC COATED ROLL-UP DOORS

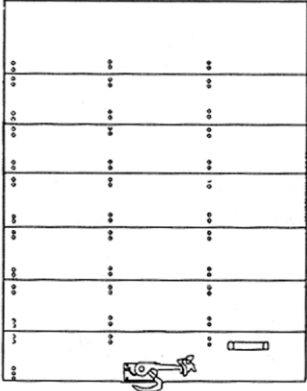

TODCO Part Number	Pro-Par Part Number	Description	Figure
TOD99610-1	MTRD90100C	90" x 100" complete	
TOD99611-1		90" x 90" complete	
TOD99861-1	MTRD90105C	90" x 105" complete	
TOD99836-1		96" x 100" complete	
TOD99837-1	MTRD96105C	96" x 105" complete	
TOD99838-1	MTRD96112C	96" x 112" complete	
TOD99610-2	MTRD90100L	90" x 100" LTO	
TOD99611-2		90" x 90" LTO	
	MTRD90105L	90" x 105" LTO	
TOD99836-2		96" x 100" LTO	
TOD99837-2	MTRD96105L	96" x 105" LTO	
TOD99838-2	MTRD96112L	96" x 112" LTO	

Complete = track & operator included
 LTO = less track & operator

Universal door kits are boxed and partially assembled. All necessary hardware to mount the door is included. The hardware included are hinges, door rivets, door cables, door track, lock, operator and operator brackets.

6: Doors & Accessories

6.9.4: TODCO & TODCO STYLE ROLL-UP DOOR REPLACEMENT PANELS
6.9.4.1: 3/4" PLASTIC COATED ROLL-UP DOOR TONGUE & GROOVE REPLACEMENT PANELS

 Top		
 Intermediate		
3/4" T&G Top Panel		
TODCO Part Number	Pro-Par Style Part Number	Size
TOD29013-15X90		15" x 90"
TOD29013-15X96		15" x 96"
3/4" T&G Intermediate Panel		
TOD29014-11X90		11" x 90"
TOD29014-12X90		12" x 90"
TOD29014-15X90	MTRD751590TI	15" x 90"
TOD29014-11X96	MTRD751196TI	11" x 96"
TOD29014-12X96	MTRD751296TI	12" x 96"
TOD29014-13X96	MTRD751396TI	13" x 96"
TOD29014-15X96	MTRD751596TI	15" x 96"
TOD29014-18X96	MTRD751896TI	18" x 96"
TOD29014-11X98	MTRD751198TI	11" x 98"
TOD29014-12X98	MTRD751298TI	12" x 98"
TOD29014-13X98		13" x 98"
TOD29014-15X98	MTRD751598TI	15" x 98"
TOD29014-18x98		18" x 98"

		
3/4" T&G Bottom Panel		
TODCO Part Number	Pro-Par Style Part Number	Size
TOD29016-11X90		11" x 90"
TOD29016-12X90		12" x 90"
TOD29016-15X90		13" x 90"
TOD29016-15X90		15" x 90"
TOD29016-1-11X96	MTRD751196TB	11" x 96"
TOD29016-12X96	MTRD751296TB	12" x 96"
TOD29016-13X96	MTRD751396TB	13" x 96"
TOD29016-15x96	MTRD751596TB	15" x 96"
TOD29016-18X96	MTRD751896TB	18" x 96"
TOD29016-1-11x98		11" x 98"
	MTRD751298TB	12" x 98"
	MTRD751398TB	13" x 98"
	MTRD751598TB	15" x 98"
TOD29016-18X98		18" x 98"
Note: Bottom Panels include: TOD61191 Bottom angle TOD80840-1 Bottom seal TOD61401 Lift Handle TOD61204 Bottom fixture TOD80844 Pull strap		

3/4" T&G Intermediate Panel (COLOR)		
Todco Part Number	Color	Size
TOD29014-11x95.25PPY	Yellow	11" x 95.25"

6.9.4.2: TODCO ALUMINUM CLAD ROLL-UP DOOR REPLACEMENT PANELS

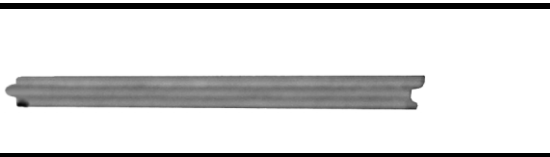

3/4" T&G Intermediate Panel	
Part Number	Size
TOD29018-11X96	11" x 96"
TOD29018-12X96	12" x 96"
TOD29018-13X96	13" x 96"
TOD29018-15X96	15" x 96"

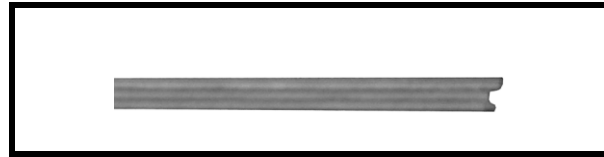

3/4" T&G Bottom Panel	
Part Number	Size
TOD29020-12X96	12" x 96"
TOD29020-15X96	15" x 96"



Bottom panel includes
no hardware

6.9.4.3: TODCO SPECIALTY ROLL-UP DOOR REPLACEMENT PANELS



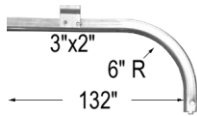
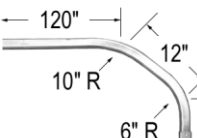
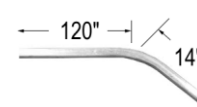
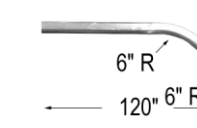
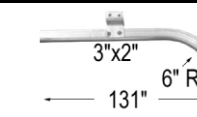
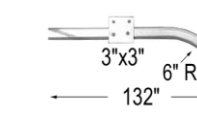

Part Number	Size	Description
TOD29842-12X97	12" x 97"	1" white aluminum clad bottom panel with lock and hardware
TOD29842-17X97	17" x 97"	1" white aluminum clad bottom panel with lock and hardware
TOD29842-9X97	9" x 97"	1" white aluminum clad bottom panel with lock and hardware
TOD29843-15X97	15" x 97"	1" white aluminum clad intermediate panel
TOD29844-15X97	15" x 97"	1" grey aluminum clad bottom panel with lock and hardware
TOD29695-2860REVDKIT21	12" x 89-1/2"	1" white aluminum clad bottom panel with lock and hardware
TOD29695-3056RVDKT16	12" x 95-1/2"	1" white aluminum clad bottom panel with lock and hardware
TOD29701-2860REVDKIT14A	12" x 96-3/4"	1" white aluminum clad intermediate panel
TOD29701-3056RVDKT9	12" x 95-1/2"	1" white aluminum clad intermediate panel
TOD29789-2860REVDKIT1A	8-1/4" x 97"	1" white aluminum clad bottom panel with special bottom seal
TOD29794-3060RKT33	12" x 97"	1" white aluminum clad bottom panel with lock and hardware
TOD29795-3060RVDKT28	12" x 96"	1" white aluminum clad intermediate panel
TOD29800-2864REVBKIT30	12" x 97"	1" white aluminum clad intermediate panel

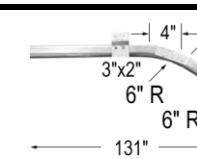
6: Doors & Accessories

6.9.5: TODCO & TODCO STYLE DOOR TRACK AND ACCESSORIES
6.9.5.1: TODCO & TODCO STYLE HORIZONTAL RACKS

TODCO Part Number	Pro-Par Part Number	Description	Figure
TOD49513-1		C/S	
TOD49513-2		R/S	
TOD49513-1/TOD49513-2		Set	
TOD49653-1		C/S	
TOD49653-2		R/S	
TOD49653-1/49653-2		Set	
TOD49702-1	MTRD416000	C/S	
TOD49702-2	MTRD415000	R/S	
TOD49702-1/49702-2		Set	
TOD49721-1		C/S	
TOD49721-2		R/S	
TOD49864-1		C/S	
TOD49864-2		R/S	
TOD49864-1/49864-2		Set	
TOD49895-5		C/S	
TOD49895-6		R/S	
TOD41040-1		C/S	
TOD41040-2		R/S	
TOD41042		C/S	
TOD41043		R/S	
TOD49464-1		C/S	
TOD49464-2		R/S	

6.9.5.2: TODCO & TODCO STYLE VERTICAL TRACKS

TODCO Part Number	Pro-Par Part Number	Description	Figure
TOD49014-1	MTRD412000	C/S	 119"
TOD49014-2	MTRD411000	R/S	
TOD49014-1/49014-2		Set	
TOD49458-1		C/S	 110"
TOD49458-2		R/S	
TOD49499-1		C/S	 98"
TOD49499-2		R/S	
TOD49562-1		C/S	 109"
TOD49562-2		R/S	
TOD49836-1		C/S	 114"
TOD49836-2		R/S	

6.9.5.3: TODCO & TODCO STYLE UNIVERSAL TRACK & OPERATOR KITS

Part Number	Description	Figure
TOD80867	Includes: Operator & brackets 2 vertical tracks 2 horizontal tracks	
DOR10-12		



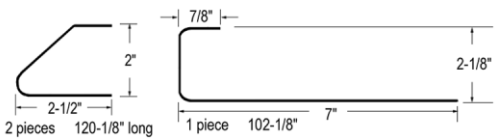

6.9.5.4: TODCO & TODCO STYLE SWING DOOR TO ROLL-UP DOOR CONVERSION KITS

Part Number	Description	Figure
TOD70411-1	Includes: 2 rear posts 1 rear header	

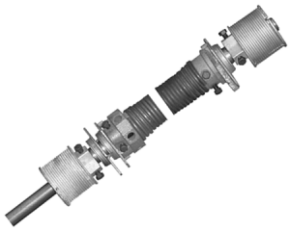

6: Doors & Accessories

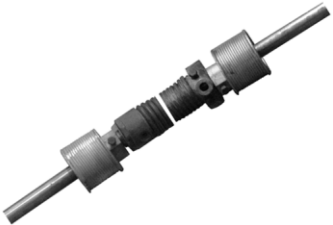
6.9.6: TODCO & TODCO STYLE BALANCERS (OPERATORS), BRACKETS, & ACCESSORIES

6.9.6.1: TODCO & TODCO STYLE BALANCERS (OPERATORS)

		
<p>1. TOD59174 2. MTRD300000</p>	<p>1. TOD59209</p>	<p>1. TOD59230</p>
		
<p>1. TOD59283-1</p>	<p>1. TOD59283-2</p>	<p>1. TOD59292</p>

6.9.6.2: TODCO & TODCO STYLE BALANCER (OPERATOR) BRACKETS

		
<p>1. TOD59138-1 C/S 2. TOD59138-2 R/S</p>	<p>1. TOD51036-1 C/S 2. MTRD3601000 C/S 3. TOD51036-2 R/S 4. MTRD3600000 R/S</p>	<p>1. TOD59206 Bearing with bracket</p>

6.9.6.3: MISCELLANEOUS TODCO & TODCO STYLE BALANCER (OPERATOR) ACCESSORIES

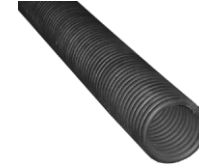
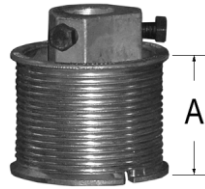

1. TOD59129-1 C/S aluminum cable drum	A = 2-1/8"	1. MTRD350000	40" Spring
2. TOD59129-2 R/S aluminum cable drum	A = 2-1/8"	2. TOD59031	50-1/2" Spring
3. TOD59129-3 C/S plastic cable drum	A = 2-1/8"	3. MTRD350200	57" Spring
4. TOD59129-4 R/S plastic cable drum	A = 2-1/8"	4. TOD51042	57-1/2" Spring
5. TOD59157-3 C/S aluminum cable drum	A = 2-1/2"	5. TOD51042-NWT	74-3/8" Spring
6. TOD59157-4 R/S aluminum cable drum	A = 2-1/2"		



1. TOD51065	50-1/2" Spring w/plugs	1. TOD59158	Spring winding plug	1. TOD51043	Spring anchor plug
		2. MTRD340100		2. MTRD340000	



1. TOD51037	90" Shaft	1. TOD51038	Bearings	1. TOD59083	Bearings
2. TOD51037-3060	95-5/8" Shaft				
3. MTRD310000	95-5/8" Shaft				

6.9.7: TODCO & TODCO STYLE DOOR CABLES







6.9.7.1: TODCO DOOR CABLES

Part Number	Size	Description	Figure
TOD51044	110"	S/S Outside application 1/4" eye	
TOD59004	115"	S/S Outside application 1/4" eye	
TOD59003	130"	S/S Outside application 1/4" eye	

6.9.7.2: TODCO STYLE DOOR CABLES

Part Number	Size	Description	Figure
TOD20658800	110"	S/S—1/4" eye	
TOD20658803	130"	S/S—1/4" eye	
TOD20658810	110"	Galvanized—1/4" eye	
TOD20658813	130"	Galvanized—1/4" eye	
TOD20658815	115"	Galvanized—1/4" eye	
WHI4020	110"	S/S—1/4" eye	
WHI4020-1	115"	S/S—1/4" eye	

6.9.8: TODCO & TODCO STYLE 1" DOOR ROLLERS

		
1. TOD61174 1" Steel	1. TOD69162 1" Sealed	1. TOD69774 1" Nylon
		
1. TOD70305 1" Steel	1. TOD70317-2 1" Steel	1. TOD80020 Roller spacer washer

6.9.9: TODCO 2" DOOR ROLLERS (WHITING STYLE)

	
Whiting Style	Whiting Style
1. TOD70224 2" Steel	1. TOD70225 2" Nylon

6.9.10: TODCO HINGES

6.9.10.1: TODCO STANDARD HINGES



1. TOD69035 End hinge
2. TOD69035-0000-05 E-coated

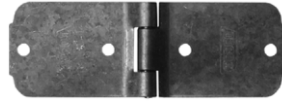

1. TOD61196 Center hinge

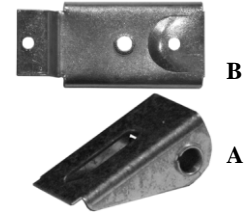

1. TOD69431 Top slide bracket; A
2. TOD69432 Top slide base plate; B



A & B

1. TOD69433 Top slide assembly

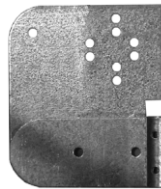

C/S Shown

1. TOD69986-1 C/S bottom plate
2. TOD69986-2 R/S bottom plate

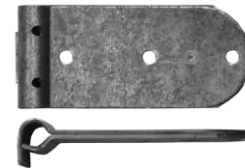

1. TOD61352 Bottom fixture



1. TOD61355 Top fixture



1. TOD69265 Top fixture

6.9.10.2: TODCO HEAVY DUTY HINGES



1. TOD70236 End hinge



1. TOD70238 Center hinge



1. TOD70311 Removable end hinge

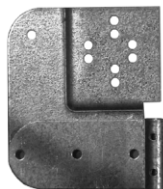













C/S shown

1. TOD69964-1 C/S
2. TOD69964-2 R/S

6: Doors & Accessories

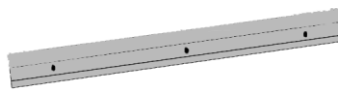
6.9.11: TODCO & TODCO STYLE DOOR SEALS & RETAINERS

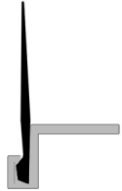
 <p>Seal comes in pairs.</p> <ol style="list-style-type: none"> TOD61390 115" Side Seal MTRD620200 96" MTRD620400 110" 	 <ol style="list-style-type: none"> TOD61402 96" Head seal MTRD630300 	 <p>Use TOD69790 retainer</p> <ol style="list-style-type: none"> TOD69718 92" Head MTRD640100 92" TOD69718X93 93" TOD69718X96 96" TOD69718X108 108"
 <ol style="list-style-type: none"> TOD69840 110" Side seal MTRD620600 	 <ol style="list-style-type: none"> TOD69987 97" Bottom seal 	 <ol style="list-style-type: none"> TOD69897 110" Side Seal
 <ol style="list-style-type: none"> TOD70337 98-3/8" Bottom seal quick chain 	 <ol style="list-style-type: none"> TOD70338 110" Side seal 	 <ol style="list-style-type: none"> TOD80840-90 90" Bottom seal TOD80840-96 96"
 <ol style="list-style-type: none"> TOD61403 96" Head seal retainer 	 <ol style="list-style-type: none"> TOD69790X93.5 93-1/2" Head seal TOD69790X96 96" Retainer MTRD50000 96 	 <ol style="list-style-type: none"> TOD69988 97" Bottom seal retainer
 <ol style="list-style-type: none"> TOD69770 96" Head seal assembly 	 <ol style="list-style-type: none"> TOD70001 95-1/4" 	

6.9.12: MISCELLANEOUS TODCO ACCESSORIES









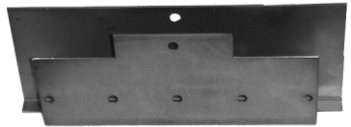

6.9.12.1: TODCO DOOR RIVETS

Part Number	Size	Figure
TOD89210-0032	1/4" x 1"	
TOD89210-0036	1/4" x 1-1/8"	
TOD89210-0040	1/4" x 1-1/4"	
TOD89210-0044	1/4" x 1-3/8"	
TOD89210-0048	1/4" x 1-1/2"	







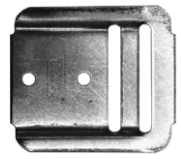
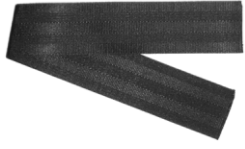



6.9.12.2: TODCO & TODCO STYLE CARRIAGE BOLTS & NUTS

Part Number	Size	Description	Figure
TOD80015-0040	1/4" x 1-1/4"	Bolt only	
TOD80015-0052	1/4" x 1-5/8"	Bolt only	
ARM11300	1/4" x 1-1/4"	Bolt & star nut	
TOD89004-1	1/4" x 1-1/2"	Bolt only	

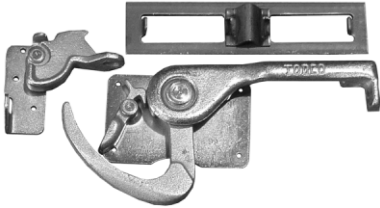
6.9.13: MISCELLANEOUS TODCO & TODCO STYLE ACCESSORIES

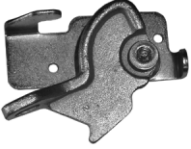
		
1. TOD80300-2414 Set screw	1. TOD89280-1 S/S screw	1. TOD882B Door Sleeve
		
1. TOD49070 Track cup	1. TOD49145 Track coupler	1. TOD59092 Filler plug
		
1. TOD61026 Cable anchor pin	1. TOD61191-90 90" Bottom angle 2. TOD61191-95 95-1/4"	1. TOD61204 Cable anchor bracket
		
1. TOD61401 Lift handle	1. TOD69832 Pull strap retainer	1. TOD80844-16 16" pull strap 2. TOD80844-30 30" 3. TOD80844-38 38"

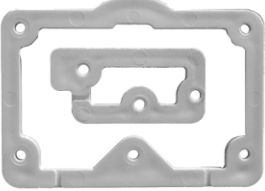
6: Doors & Accessories

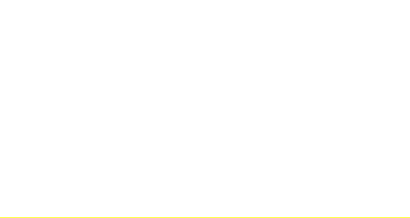
		
<p>1. TOD70306-051210" alum. fork lift plate 2. MTRD370250</p>	<p>1. TOD69020 Safety chain assembly</p>	<p>1. TOD61223 Safety chain lock</p>
		
<p>1. TOD61229 Safety chain</p>	<p>1. TOD69570 Lock kit</p>	<p>1. TOD69571 Todco lock 2. MTRD280000 Todco style lock</p>
		
<p>1. TOD69572 Keeper 2. MTRD281000 Keeper</p>	<p>3. TOD70223 Offset lock</p>	<p>4. TOD69341 Latch box</p>
		
<p>1. TOD70057 Large nylon spacer 2. TOD70058 Small nylon spacer</p>	<p>1. FRUDCE2015-1 Latch plate</p>	<p>1. TOD</p>

6.9.14: TODCO LUBRICANTS

		
<p>1. TOD39000-1006 4 oz.</p>	<p>1. TOD39000-1008 12 oz.</p>	<p>1. TOD39000-1016 1 gallon</p>

6.10 Whiting Roll-Up Doors, Door Panels & Accessories

6.10.1: EXPLODED VIEW OF WHITING 3/4" TONGUE & GROOVE DRY FREIGHT DOOR

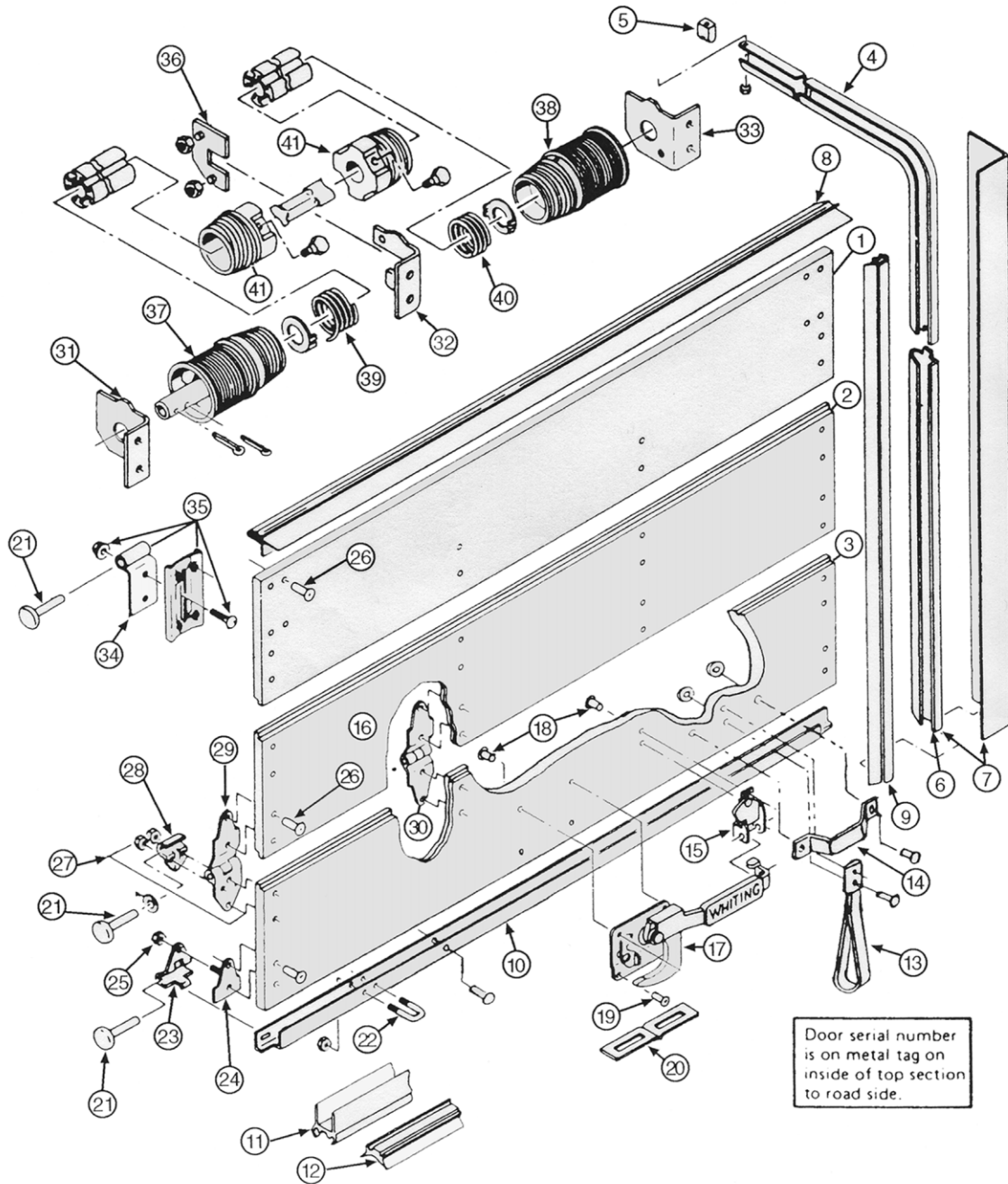

6: Doors & Accessories

6.10.2: DETAIL OF WHITING 3/4" TONGUE & GROOVE DRY FREIGHT DOOR

Item	Part Number	Description
1	340-15X96	Top plain, plastic (use intermediate panel & cut)
2	WHI342-15X96	Intermediate plain, plastic
3	WHI346-15X96	Bottom plain, plastic
4	WHI11-4 WHI11-5	C/S 2" horizontal track 10' long R/S 2" horizontal track 10' long
5	WHI83	2" Track stop bumper
6	WHI1031	LH & RH 2" vertical track, 90" long
7	WHI2275-1 WHI2275-2	R/S 2" vertical track with angle 90" C/S 2" vertical track with angle 90"
8	WHI4032W	Top seal 96"
9	WHI5423	Side seal 100"
10	WHI18-3-77	Bottom U channel—96"
11	WHI1801-96	Bottom seal retainer—96"
12	WHI1676	Bottom seal
13	WHI23-1 23-2	Pull strap 19" Pull strap 42"
14	WHI1715	Grab handle
15	WHI7515	Handle keeper
16	WHI33	Knurled hinge pin
17	WHI77	Lock assembly—no keeper
18	WHI10-1002-42	Rivet 1/4" x 1-1/16"—3/4" head
19	WHI10-1002-9	Rivet 1/4" x 1-5/16"—1/2" head
20	WHI2804	Latch plate
21	WHI3228 WHI2996	2" Roller nylon 2" Roller metal
22	WHI70-13 WHI70-5	1-1/4" U bolt 1-1/2" U bolt
23	WHI1021	Bottom roller hinge cover
24	WHI1370	Bottom hinge bracket plate
25	WHI10-1022-1	1/4" Lock nuts
26	WHI10-1002-3	Rivet 1/4" x 1"—3/4" head
27	WHI1209-A	End hinges complete with cover
28	WHI1208	Roller hinge cover
29	WHI1207	Roller hinges
30	WHI15	Center hinges
31	WHI2524	Balance bracket roadside
32	WHI2525	Balance bracket center
33	WHI2523	Balance bracket curbside
34	WHI6943	Top closure hinges
35	WHI6944	Top hinge assembly
36	WHI2526	Balance bracket clamp
37	WHI2547	Cable drum roadside
38	WHI2548	Cable drum curbside
39	WHI2704	Torsion spring C/S
40	WHI2705	Torsion spring R/S
41	WHI2518	Winding cone

6.10.3: WHITING ROLL-UP DOORS

6.10.3.1: WHITING PREMIUM 3/4" PLASTIC COATED ROLL-UP DOORS

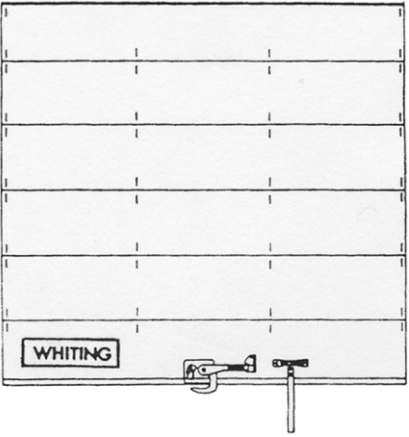
Part Number	Description	Figure
WHI20653751	90" x 90" Complete	
WHI20653759	90" x 100" Complete	
Includes Track & Operator, Standard Hardware—No Seal		
WHI20653752	90" x 90" LTO	
WHI20653784	90" x 100" LTO	
WHI20653782	96" x 100" LTO	
WHI20653796	96" x 107" LTO	
Less Track & Operator—No Seal		
WHI20653780	96" x 100"	
WHI20653781	96" x 107"	
Includes Track & Operator, Heavy Duty Hardware—No Seal		

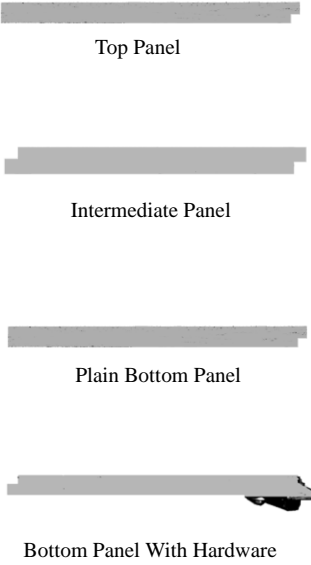

6.10.4: WHITING & WHITING STYLE ROLL-UP DOOR REPLACEMENT PANELS

6.10.4.1: 3/4" SHIPLAP ROLL-UP DOOR REPLACEMENT PANELS

Whiting Part Number	Size	Description	Figure
WHI240-15X96	15" x 96"	Top panel	
WHI242-11X96	11" x 96"	Intermediate panel	
	11" X 98"	Intermediate panel	
WHI242-12X96	12" x 96"	Intermediate panel	
WHI242-13X96	13" x 96"	Intermediate panel	
WHI242-14X96	14" x 96"	Intermediate panel	
WHI242-15X90	15" x 90"	Intermediate panel	
WHI242-15X96	15" x 96"	Intermediate panel	
WHI242-15.5x96	15.5" x 96"	Intermediate panel	
WHI243-12X96	12" x 96"	Plain bottom panel	
WHI243-13X96	13" x 96"	Plain bottom panel	
WHI243-15X90	15" x 90"	Plain bottom panel	
WHI243-15X96	15" x 96"	Plain bottom panel	
WHI246-11X96	11" x 96"	Bottom panel complete with lock, handle, pull strap & bottom roller bracket.	
WHI246-12X90	12" x 90"		
WHI246-12x96	12" x 96"		
WHI246-13X96	13" x 96"		
WHI246-15X96	15" x96"		

6: Doors & Accessories



6.10.4.2: 3/4" TONGUE & GROOVE ROLL-UP DOOR REPLACEMENT PANELS

Part Number	Size	Description	Figure
WHI342-11X96	11" x 96"	Intermediate panel	
WHI342-12X96	12" x 96"	Intermediate panel	
WHI342-13X96	13" x 96"	Intermediate panel	
WHI342-15X98	15" x 98"	Intermediate panel	
WHI343-13x96	13" x 96"	Plain bottom panel	
WHI343-15x98	15" x 98"	Plain Bottom panel	
WHI346-11X96	11" x 96"	Bottom panel with hardware	
WHI346-12X96	12" x 96"	Bottom panel with hardware	
WHI346-15X96	15" x 96"	Bottom panel with hardware	

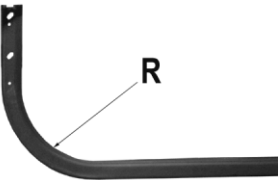
6.10.5: WHITING HORIZONTAL TRACKS

Part Number	Description	Figure
WHI11-2	C/S 127" R = 8"	
WHI11-3	R/S 127" R = 8"	
WHI11-4	C/S 127" R = 10"	
WHI11-5	R/S 127" R = 10"	
WHI4092	R/S 127" R = 6"	
WHI4093	R/S 127" R = 6"	

6.10.6: WHITING VERTICAL TRACKS

Part Number	Description	Figure
WHI1031	C/S or R/S—90"	
WHI4045	R/S with mtng angle—107"	
WHI4046	C/S with mtng angle—107"	

6.10.7: MISCELLANEOUS WHITING BALANCERS (OPERATORS) & ACCESSORIES



1. WHI2376-87 87" Balancer
 2. WHI12376-200x30 90" Balancer
 3. WHI2376-93 93" Balancer

1. WHI2322 Center support bracket



1. WHI2525 A = Center bracket
 2. WHI2526 B = Clamp

1. WHI152 C/S bracket
 2. WHI153 R/S bracket

1. WHI2547 R/S cable drum
 2. WHI2548 C/S cable drum



1. WHI2518 Spring winding con.

1. WHI2704 R/S torsion spring
 2. WHI2705 C/S torsion spring

1. WHI4127 C/S cable drum
 2. WHI4128 R/S cable drum

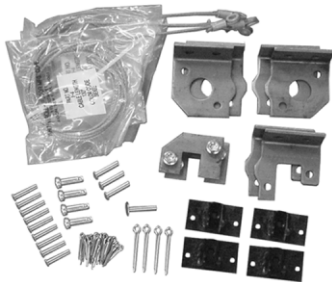

1. WHI3187 Conversion kit from 1776 to 2376

6: Doors & Accessories

6.10.8: WHITING & WHITING STYLE DOOR CABLES
6.10.8.1: WHITING DOOR CABLES

Part Number	Size	Description	Figure
WHI1-1	125"	S/S 5/16" eye white	
WHI1-11-BLACK	115"	S/S 5/16" eye black	
WHI1-2	156"	S/S 5/16" eye orange	
WHI1-4	130"	S/S 5/16" eye beige	
WHI1-7	97"	S/S 5/16" eye plain	
WHI1-8	110"	S/S 5/16" eye	
WHI112-1	105"	S/S 7/16" eye yellow	
WHI112-2	115"	S/S 7/16" eye green	
WHI112-3	125"	S/S 7/16" eye red	
WHI112-4	135"	S/S 7/16" eye blue	
WHI112-6	95"	S/S 7/16" eye brown	



6.10.8.2: WHITING STYLE DOOR CABLES

Part Number	Size	Description	Figure
DOR10-1	105"	SS 5/16" eye	
DOR10-2	110"	SS 5/16" eye	
DOR10-3	115"	SS 5/16" eye	
DOR10-4	125"	SS 5/16" eye	
DOR10-5	130"	SS 5/16" eye	
DOR10-6	105"	S/S 7/16" eye	
DOR10-7	115"	S/S 7/16" eye	
DOR10-8	125"	S/S 7/16" eye	
DOR10-9	130"	S/S 7/16" eye	
DOR10-10	145"	S/S 7/16" eye	
DOR10-11	156"	S/S 7/16" eye	
FLT1-1W	125"	Galvanized 5/16" eye	
FLT1-4W	130"	Galvanized 5/16" eye	
WHI20653821	115"	Galvanized 5/16" eye	
WHI20653818	125"	Galvanized 5/16" eye	





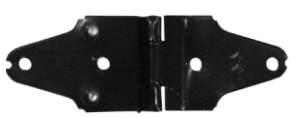
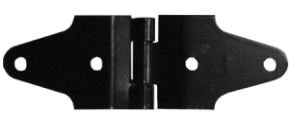
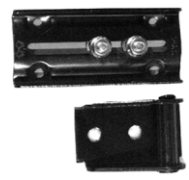

6.10.9: WHITING & WHITING STYLE 2" DOOR ROLLERS

		
1. WHI2996-1 2" Steel with 4" shaft	1. WHI2996 2" Steel Whiting 2. TOD70224 Todco version	1. WHI3228 2" Nylon Whiting 2. TOD70225 Todco version

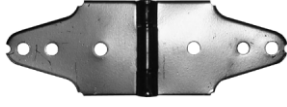
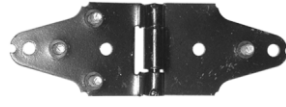
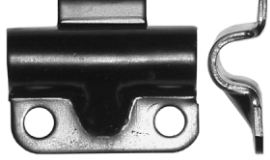
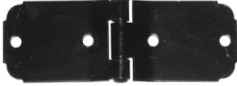

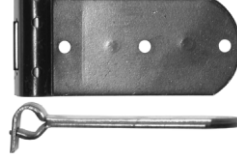

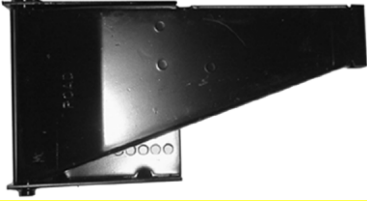

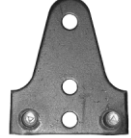
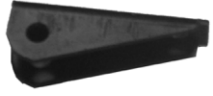
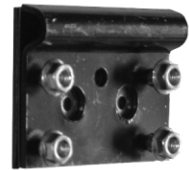

6.10.10: WHITING & WHITING STYLE HINGES & BRACKETS

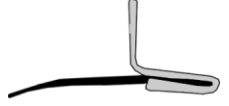
		
1. WHI1207 Roller hinge 2. MTRD810100	1. WHI1208 Roller hinge clamp 2. MTRD810200	1. WHI1209-A Complete roller hinge 2. MTRD810000
		
1. WHI15 Center hinge 2. MTRD810500	1. WHI6943 Top slider closure 2. MTRD820100	1. WHI6944 Top slider assembly 2. MTRD820000
		
1. WHI1021 Bottom roller hinge cover 2. MTRD830000	1. WHI1022 Bottom roller bracket	1. WHI1370 Bottom roller stud plate 2. MTRD830100
		
1. WHI1371-A Bottom bracket assembly 2. MTRD830200	1. WHI2211 Bottom roller clamp	1. WHI85 Bottom roller bracket

6: Doors & Accessories

 <p>"Cargo Saver"</p> <p>1. WHI2915 Center hinge</p>	 <p>"Cargo Saver"</p> <p>1. WHI8070 Roller hinge</p>	 <p>"Cargo Saver"</p> <p>1. WHI6842 Roller clamp</p>
 <p>Todco Style</p> <p>1. WHI4012 Center hinge</p>	 <p>Todco Style</p> <p>1. WHI4007 Roller hinge</p>	 <p>Todco Style</p> <p>1. WHI4003 Bottom roller brackets</p>
 <p>Todco style</p> <p>1. WHI4038 Top slide bracket</p>	 <p>1. WHI1336-1 C/S top panel closure bkt 2. WHI1336-2 R/S top panel closure bkt</p>	 <p>1. WHI1920 Top closure mounting bkt</p>
 <p>1. WHI2032 Bottom roller stud plate 2. MTRD830300</p>	 <p>1. WHI4004 Cable anchor bracket</p>	 <p>1. WHI5600 Bottom roller bracket</p>

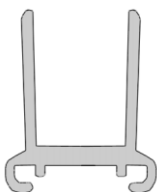
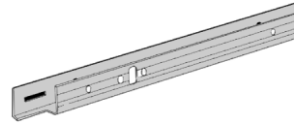
6.10.11: WHITING DOOR SEALS & RETAINERS

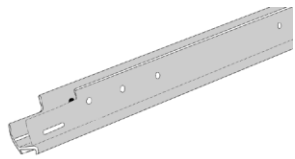
		
1. WHI2531 Top seal	1. WHI4032 97-7/8" Top seal	1. WHI5423 2. WHI5423-120 100" Side seal 120"
		
1. WHI7470 Side seal insulated door	1. WHI6388 Bottom slide	1. WHI4034W Bottom seal retainer
		
1. WHI1676 Bottom seal	1. WHI1675 96" Bottom U-Channel	1. WHI18-3-70 2. WHI18-3-77 U-channel cutout for #70 lock Cutout #77 lock
		
1. WHI18-3-90 2. WHI1801-96 90" 96"	1. WHI8280-2 Bottom channel 96"	

6.10.12: WHITING RIVETS & STEP (CARRIAGE) BOLTS









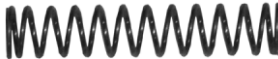

6.10.12.1: WHITING RIVETS

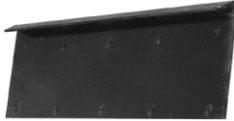

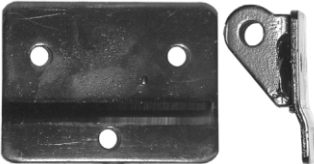
Part Number	Size	Head	Figure
WHI10-1002-3	1/4" x 1"	3/4"	
WHI10-1002-36	1/4" x 1-1/8"	3/4"	
WHI10-1002-4	1/4" x 1-3/16"	3/4"	
WHI10-1002-42	1/4" x 1-1/16"	3/4"	
WHI10-1002-9	1/4" x 1-5/16"	1/2"	

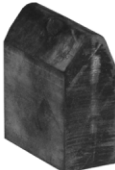
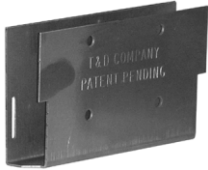
6.10.12.2: WHITING STEP (CARRIAGE) BOLTS & NUTS

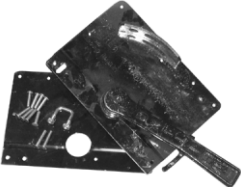
Part Number	Size	Head	Figure
WHI10-1003-11	1/4"—20" x 1-1/2"		
WHI10-1003-2	1/4"—20" x 1-3/4"		
WHI10-1003-8	1/4"—20" x 1-1/4"		
WHI10-1022-1	1/4"—Self-locking nut		

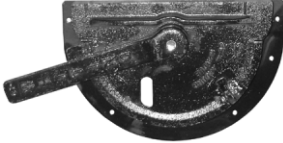
6.10.13: MISCELLANEOUS WHITING & WHITING STYLE DOOR ACCESSORIES

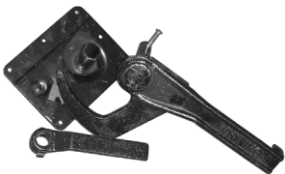
 1. WHI10-1009-13 Cotter pin	 1. WHI10-1012-8 .480" x 3" Spring	 1. WHI70-13 1-1/4" U-bolt 2. MTRD830500 1-1/4" U-bolt 3. WHI70-5 1-1/2" U-bolt 4. WHI70-10 2-1/4" U-bolt
 1. WHI23 19" pull strap 2. WHI9723-1 32" pull strap 3. WHI23-2 42" pull strap	 1. WHI1092 Fork lift plate	 1. WHI1715 Grab handle
 1. WHI5803 Cable anchor	 1. WHI33 Knurled pin	 1. WHI6 7/16" Roller shaft space washer
 1. WHI83 Track stop bumper	 1. WHI882A Door Sleeve	 1. WHI2804 Latch plate
 1. WHI70 Recessed lock	 1. WHI75 Surface mount lock	 1. WHI75-10 Surface mount lock for insulated door

		
<p>1. WHI77 Outside cam lock</p>	<p>1. WHI77-1 Offset cam lock</p>	<p>1. WHI3225 #77 Lock with inside release handle</p>
		
<p>1. WHI4077 General purpose duel lock</p>	<p>1. WHI86 Handle for lock #70</p>	<p>1. WHI87 Handle for lock #75</p>
		
<p>1. WHI70-1 Door lock cam for #70 lock</p>	<p>1. WHI7515 Handle keeper for #77 lock</p>	<p>1. WHI10-1027-1 7/8" x 6" chain link</p>
		
<p>1. WHI4126 8" Safety chain</p>	<p>1. WHI57 Safety chain lock</p>	<p>1. WHI59 Chain lock no chain</p>

6: Doors & Accessories

